

Installation Instructions

Fibre distribution cabinet
FDC-L 2.8 in cabinet KVz22



Contents

1	General information.....	4
2	Safety information	4
3	Product description	5
3.1	Dimensions.....	5
3.2	Technical data	6
4	Scope of delivery.....	7
5	Base plate design.....	8
6	Installing the cabinet on the pedestal.....	9
7	Installing the pipe bundles / micro cables.....	10
7.1	Preparing the pipe bundles / micro cables.....	10
7.2	Mounting the micro-duct pipes in the pedestal	11
7.3	Micro-duct pipe set-up / function in the cabinet	11
7.4	Inserting the micro-duct pipes in the cabinet	12
7.5	Mounting the micro-duct pipe with strain-relief lug.....	13
8	Installation of the optical fibre main cable	14
8.1	Inserting optical fibre main cables / mini cables / bundled loose tube fibres.....	14
8.2	Loop	16
8.3	Ongoing routing of optical fibre main cables / mini cables / bundled loose tube fibres	16
9	Installation of optical fibre micro cables.....	17
9.1	Inserting the micro cables / bundled loose tube fibres (on the rear panel)	17
10	Inserting the optical fibre micro cables (at the fibre tray level)	18
11	Use of the protective cover	21
12	Description of the E&MMS fibre tray system.....	22
12.1	Organiser module (basic element)	22
12.2	Description of the splice fibre tray	23
12.3	Inserting fibre trays.....	23
12.4	Removing the fibre tray	24
12.5	Splicing fibres.....	24
12.6	Keeping fibres in reserve.....	26
12.7	Changing the direction of the fibres.....	27
12.8	Optical fibre entry port.....	27
12.9	Side optical fibre cable guide	27

12.10	Inserting the optical fibres into the fibre tray.....	28
12.11	Optical fibre bridge	29
12.12	Brackets	29
12.13	Attaching and removing the fibre tray cover	29
13	Assembly and disassembly for cabinet replacement	30
13.1	Removing the earthing	30
13.2	Removing the rear panel	30
13.3	Removing the brackets.....	31
13.4	Removing the cable routing.....	31
13.5	Loosening the mounting panel	32
13.6	Releasing the door	33
14	Double swivel lever.....	34
15	Earthing kit (accessory)	35
15.1	Earthing kit	35
15.2	Preparation.....	35
15.3	Pre-assembly of the earthing flag.....	36
15.3.1	Installation of the earthing cable (1x).....	36
15.3.2	Installation of the cable holder for Ø6 mm - Ø10 mm	36
15.4	Installing the earthing flag in the KVz22	37
16	Order data and accessories.....	37
17	Material defects	38
18	Recycling	38
19	Cleaning, repainting	38
20	Quality management.....	38
21	Disclaimer/Warranty	38
22	Contact	38

1 General information

These installation instructions describe use of the differently configured “Fibre distribution cabinet (FDC)” in the outdoor cabinet KVz22.



Note:

Any person involved in assembly, operation, maintenance and repair of the product must first read, understand and follow these instructions. We accept no liability for damage and operating malfunctions caused by failure to comply with these instructions.

Langmatz GmbH warns against the misuse of the product.

The product described here corresponds to the latest state-of-the-art technology at the time of printing and is delivered in an operationally safe condition.

Unauthorised modifications, particularly to safety-related parts, are prohibited. Langmatz GmbH warns against the misuse of the product.

The operator is responsible for the following,

- preventing danger to life and limb of users and third parties,
- ensuring safe operation,
- precluding downtime and environmental impact due to incorrect handling.

In the interest of further development, we reserve the right to change individual assemblies and accessories as considered necessary for further safety and performance improvements, while preserving the main features.

The copyright to these instructions remains with Langmatz GmbH.

2 Safety information



- Note the possibility of laser/LED radiation in the non-visible spectrum!
- Never look into open fibre ends if there is an unknown level of risk posed by laser/LED radiation.



Attention!

The level of risk should be decided ultimately by the system fitter/operator of the communication system, who is responsible for labelling the system accordingly (e.g. applying warning signs in accordance with DIN EN/IEC 60825-1, as revised, and in compliance with the BGV (Employers' Liability Association) B2 "Laser radiation", as revised).

If the technical data changes, and this affects the level of risk, the warnings must be adapted accordingly and occupational safety measures should be taken, see also DIN EN/IEC 60825-2, as revised.

- Do not use the product if it is damaged. Please contact the hotline (see reverse).
- The operating company is responsible for installing, operating and maintaining the fixtures.



Note:

The relevant occupational safety regulations must be adhered to during installation, operation and repair work.

3 Product description

The FDC consists of the following main product components:

- Cabinet KVz22 EK245/500
- Pedestal EK265 2.0 ([installation instructions](#))
- FDC installation kit
- FTTH base plate

The proper installation and configuration of the optical fibre distribution cabinet is described in detail in these installation instructions.

3.1 Dimensions

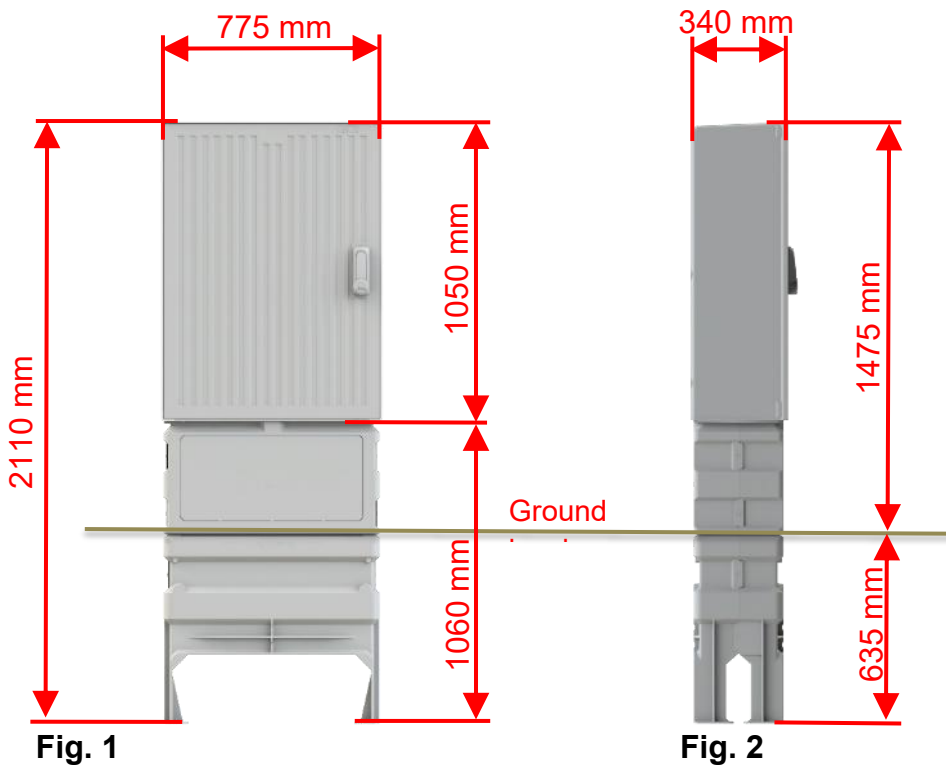

Fig. 1

Fig. 2

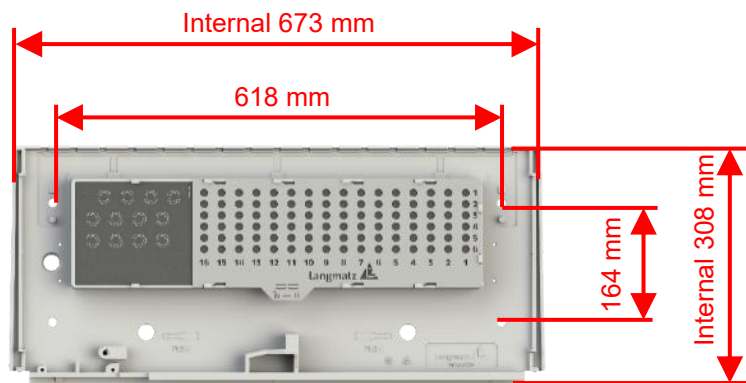

Fig. 3 Illustrated example

3.2 Technical data

Resistance to manual break-in attempts based on
EN 1630: 21-06: T3

W x H x D: 775 x 2110 x 340 mm

Weight of one cabinet (cabinet and pedestal) including packaging and pallet: 105 kg

Weight of two cabinets (cabinet and pedestal) including packaging and pallet: 180 kg

Cabinet material: Polycarbonate

Degree of protection: IP54

Resistance:

- UV-resistant, weather-resistant and self-extinguishing
- environmentally-friendly plastic and recyclable

Colour: Cabinet body coated in RAL 7038 with environmentally-friendly paint

Version:

- Ribbed surface (difficult to adhere posters to the surface)
- 7-locking mechanism with turning lever, prepared for one or two profile half-cylinders

4 Scope of delivery

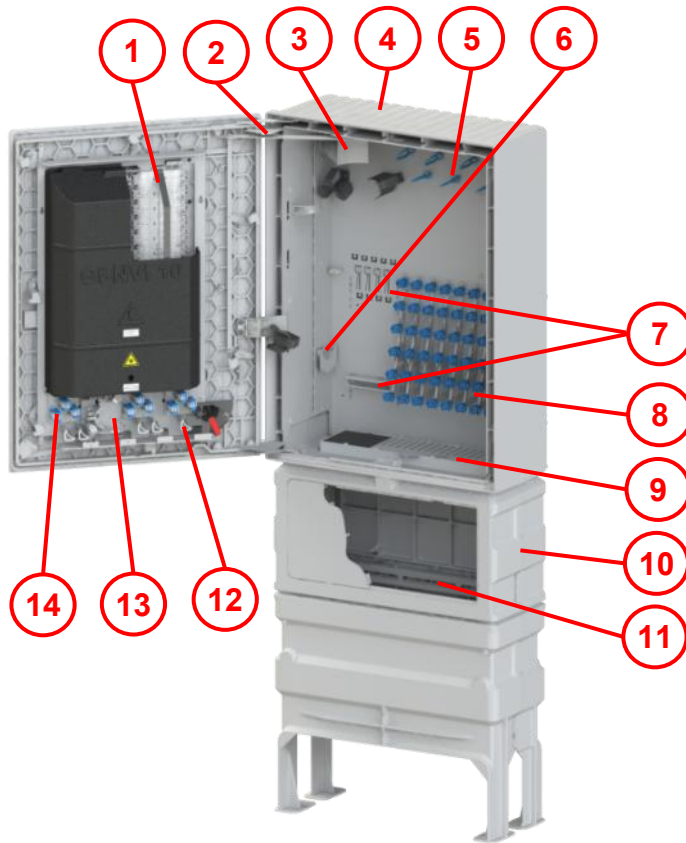

Fig. 4

Item 1	Fibre tray system level	Item 10	Pedestal (not screwed to the cabinet when delivered)
Item 2	Door stay	Item 11	Strain relief rail
Item 3	Cable diverter	Item 12	Bending radius limiter
Item 4	Cabinet KVz22	Item 13	Mounting panel, inlet (depending on the design)
Item 5	Guide rings	Item 14	Mounting panel, outlet (depending on the design)
Item 6	Excess cable tray		
Item 7	Optical fibre main cable strain relief, micro-duct pipes and core of fibre cable Not shown: Optional mounting and strain relief in the inlet area for second and third row		Not shown: Accessories kit: - 96x strain-relief lugs duo 7/10 or 60x strain-relief lugs 12 - Mandrels \varnothing 7/10/12 - Spiral hose 0.4 m - U-clamps 2x B12, 1x BK14 - 30x cable ties 140 mm - Set of screws for fixing to the pedestal
Item 8	Mount for micro-duct pipes		
Item 9	Base plate with sealing plate and strain relief (strain relief only for outlet area)		

5 Base plate design



Fig. 5

(1) Sealing plate

(2) Strain relief plate

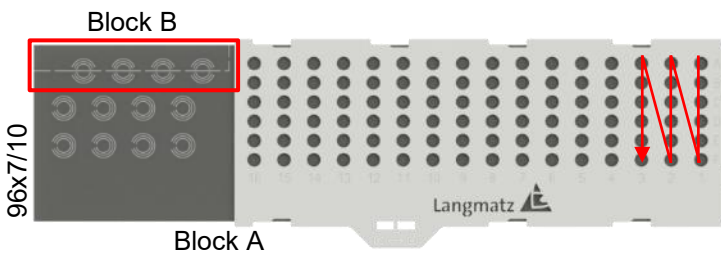

Fig. 6

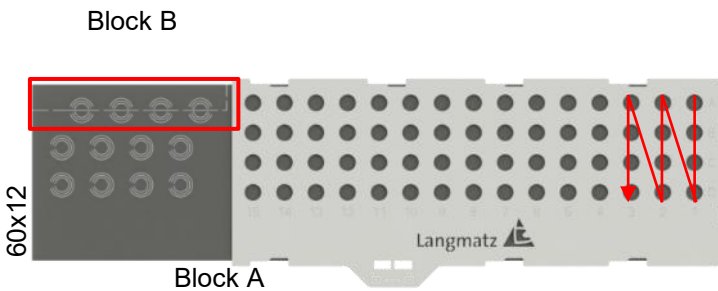

Fig. 7

Block A	Block B
6x 7/10 (Micro-duct pipe ø7 or ø10 mm)	
8x 12-20 (Micro-duct pipe ø12, ø16, ø20 / Optical fibre main cable)	4x 12-20 (Micro- duct pipe ø12, ø16, ø20 / Optical fibre main cable / Divisible cable entry element for loop)
60x 12 (Micro-duct pipe ø12 mm)	
8x 12-20 (Micro-duct pipe / Optical fibre main cable)	

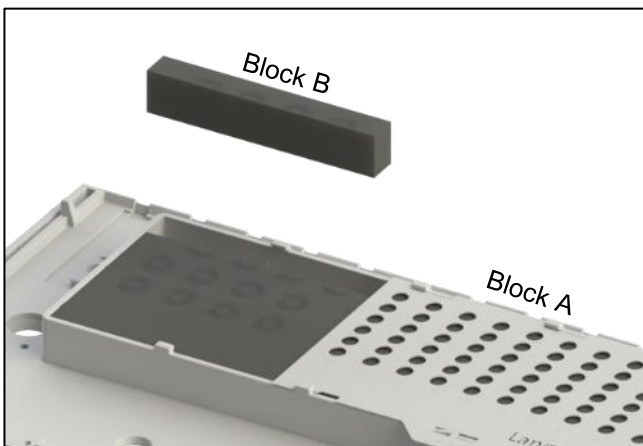

Fig. 8

The divisible sealing plate for cable entry in Block B:

- Entry point of the optical fibre main cable or micro-duct pipe
- Provides for a loop (uncut cable)

6 Installing the cabinet on the pedestal

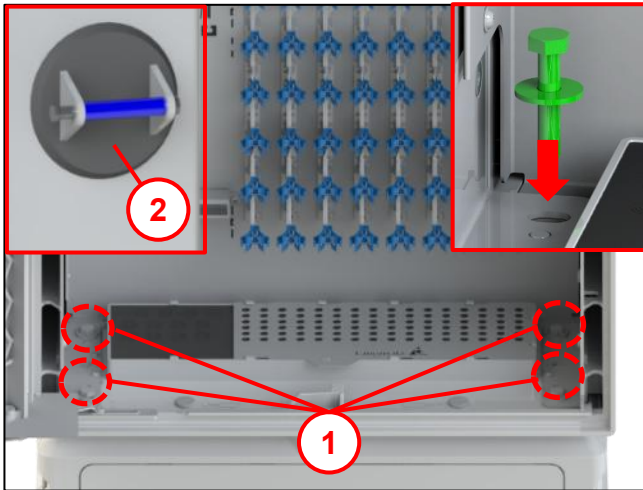

Fig. 9

Two people are needed to install the cabinet.

- Position the cabinet on the pedestal and screw together with 4x hex screws M10x50 and 4x washers 10.5 (1).

Note!

[Installation instructions pedestal](#)

Note: An appropriate suction lifter (2) can be used to lift the cabinet.

7 Installing the pipe bundles / micro cables

7.1 Preparing the pipe bundles / micro cables



Note: Use the specified tools to handle pipe bundles / micro cables.

For pipe bundles **(1)**

For micro cables **(2)**

Fig. 10

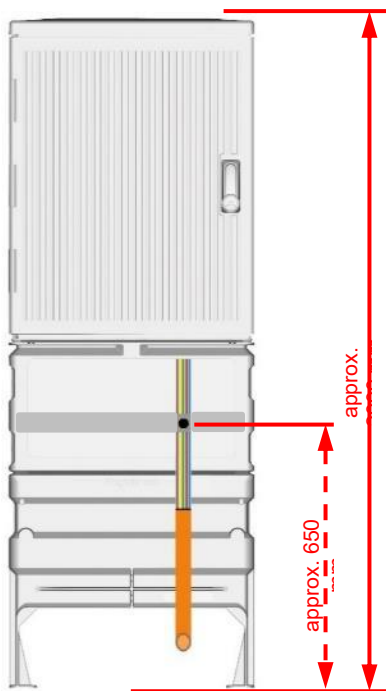
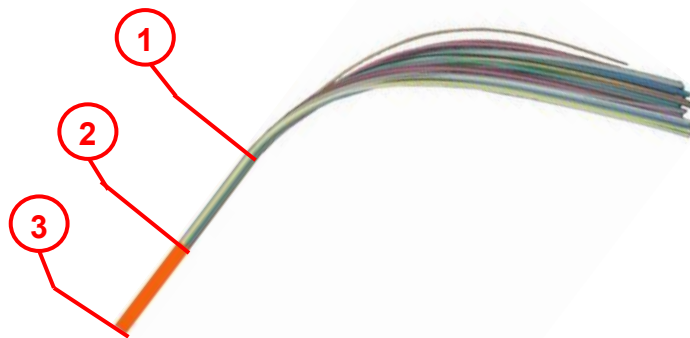

Fig. 11

The length of the micro-duct pipes is approx. 2 m from the pedestal inlet



Item 1 Upper edge of U-clamp – pedestal

Item 2 Remove the sheath

Item 3 Pedestal inlet

Note: The design, colour coding and the number of micro-duct pipes can deviate from the illustration shown depending on the manufacturing variant of the pipe bundle.

7.2 Mounting the micro-duct pipes in the pedestal

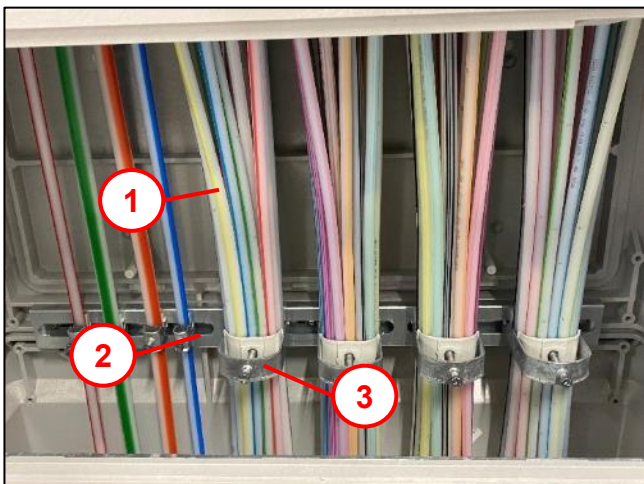

Fig. 12

- Mount the micro-duct pipes (1) on C-DIN rails (2) with U-clamps (3) (scope of delivery varies according to variant).

7.3 Micro-duct pipe set-up / function in the cabinet



Fig. 13

The micro-duct pipes are installed according to the installation matrix from rear right to front left.

They are organised by clamp mounts with Duo clamps (1) fitted on the rear panel.

Note: For reasons of space, the micro-duct pipes (3) ($\varnothing 10$ / $\varnothing 12$) and micro-duct gas stops (2) must be graduated, see Fig. 16.

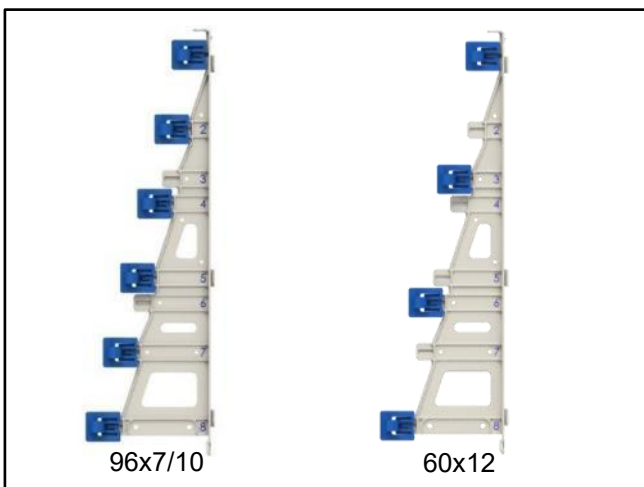

Fig. 14

The micro-duct pipes are organised and held in place using $\varnothing 7$ / $\varnothing 10$ / $\varnothing 12$ Duo clamps.

They are installed by simply clipping the micro-duct pipes into the clamps.

7.4 Inserting the micro-duct pipes in the cabinet

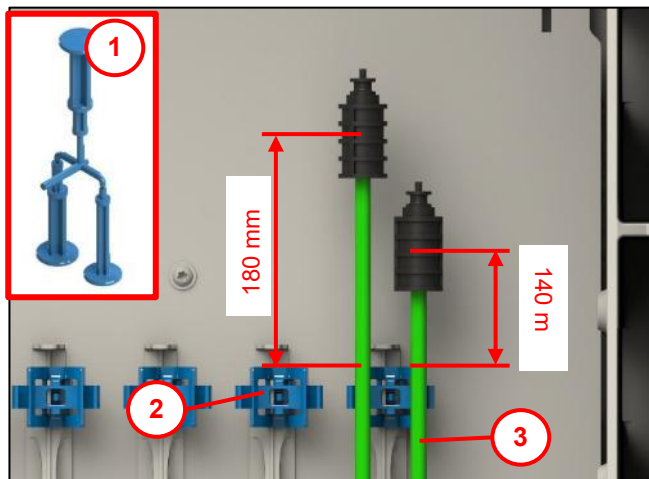

Fig. 15

- Insert the micro-duct pipes (3) into the cabinet.

Note:

Insert the micro-duct pipes through the base plate using the mandrel (1) ($\varnothing 7/10/12$ depending on the design) (note the installation note "Mandrel and insertion aid for micro-duct pipes").

There needs to be an alternate additional length of 140 mm or 180 mm above the Duo clamp (2) in order to attach sealing and labelling elements and labels.

7.5 Mounting the micro-duct pipe with strain-relief lug

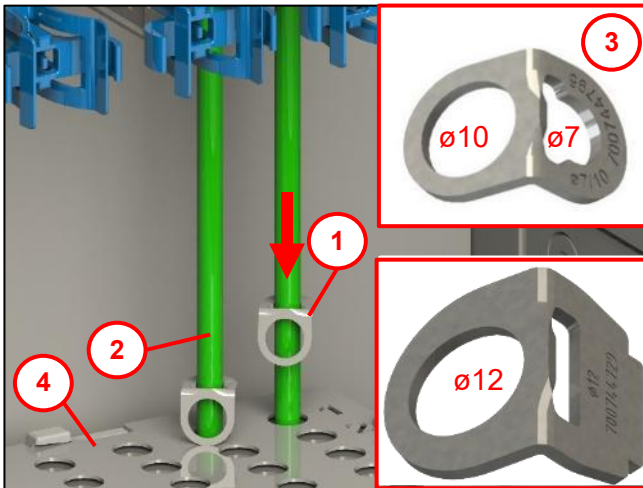

Fig. 16

- Place the strain-relief lug (1) on the micro-duct pipe (2) with the lug pointing down.

Note: Use the designated side of the strain-relief lug depending on the diameter of the micro-duct pipe and the design of the strain-relief lug duo (3) for 7/10 mm micro-duct pipes (one lug for two sizes).

- Push the strain-relief lug (1) over the micro-duct pipe (2) as far as the strain relief plate stop (4).

The strain relief plate also fixes the micro-duct pipes in place and provides strain relief.



Fig. 17

Note: Arrange the strain-relief lugs pointing in the same direction!

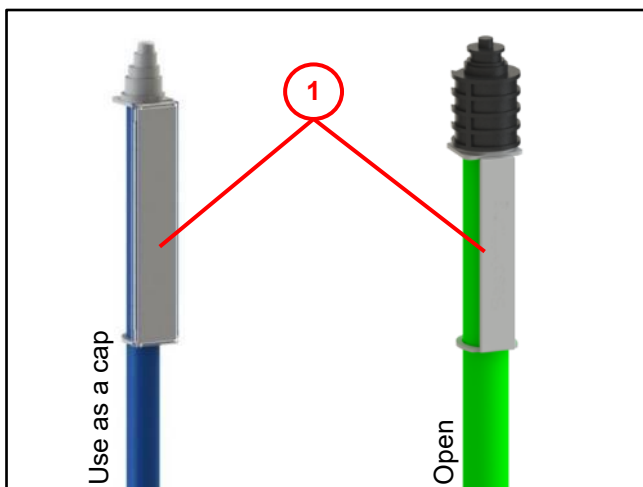

Fig. 18

If labelling plates (1) are to be fitted, they must be installed prior to installation of the sealing elements.

8 Installation of the optical fibre main cable

Note: The following options are available to route the cables or bundled loose tube fibres for the four mounting points on the rear panel:

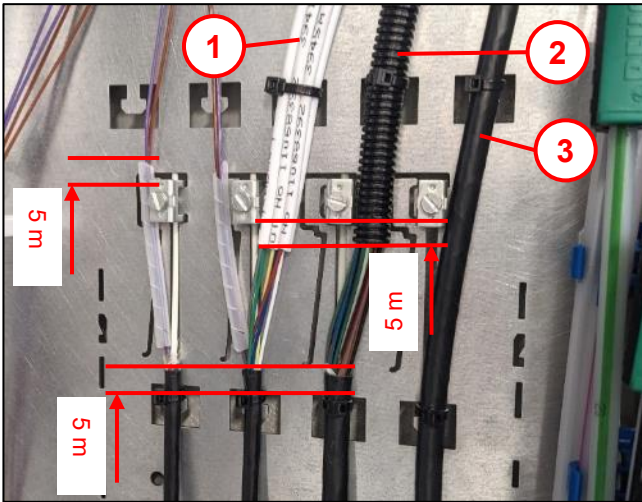

Fig. 19

- Cables **(3)** on the door max. $\varnothing 10$.
- Bundled loose tube fibres in a corrugated tube **(2)** max. $\varnothing 13.5$ on the door.
- Bundled loose tube fibres in protective tubes $6 \times \varnothing 4$ **(1)** on the door.

Note: Store cables that are not currently required on the excess cable tray.

Regarding fixing on the cable organiser on the door see Fig. 26.

8.1 Inserting optical fibre main cables / mini cables / bundled loose tube fibres

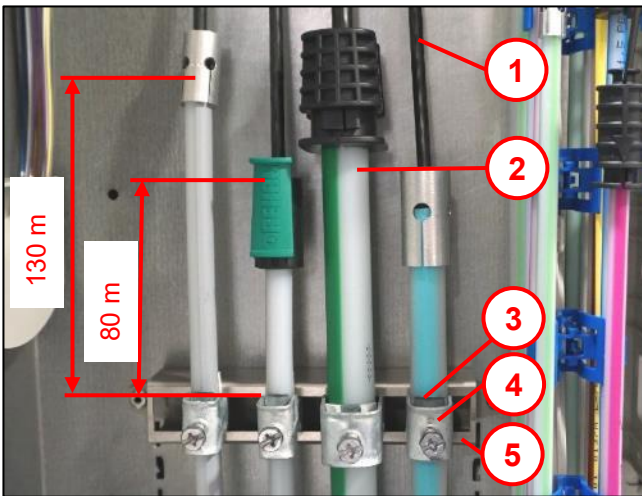

Fig. 20

- Insert the micro-duct pipes **(2)** for the optical fibre mini cable **(1)** into the cabinet through the base plate (inserting micro cables, see section 7.4).
- Fix the micro-duct pipe with U-clamp **(5)** and counter-trough, double trough **(4)** onto the C-DIN rail **(5)**.
Note: Only tighten the fastening screw **hand-tight**.
- Alternately, strip the micro-duct pipe 80 mm or 130 mm above the C-DIN rail.
- Insert the optical fibre mini cables (sealing elements according to the manufacturer's installation instructions) or air cables.

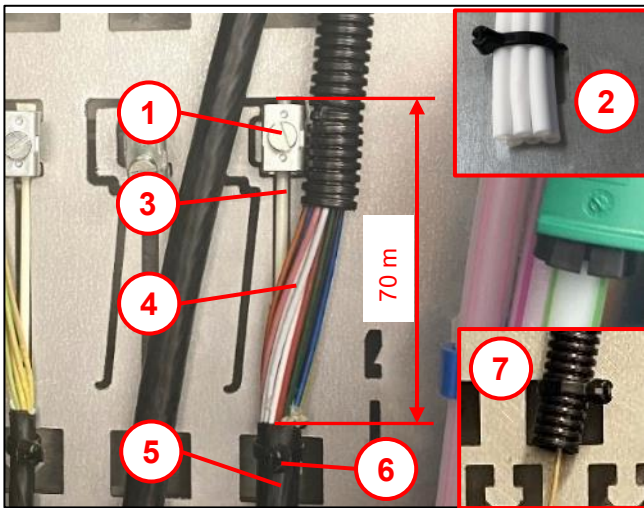

Fig. 21

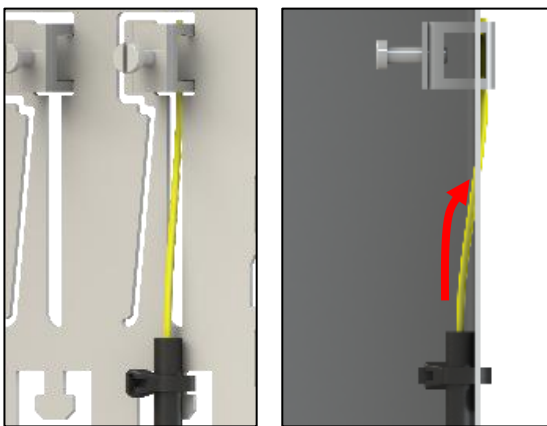

Fig. 22 Illustration without bundled loose tube fibres

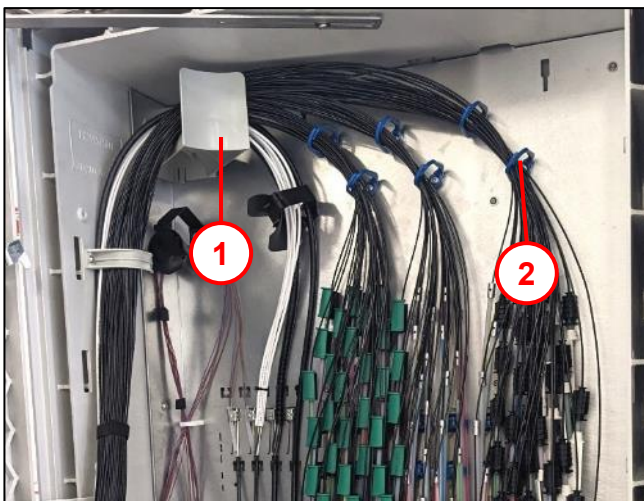

Fig. 23

- Strip the core of fibre cable (3) to 70 mm. **Note:** Alternative strain relief on the door side, see Fig. 26.
- Strip the bundled loose tube fibres (4) as per the specification.
- Depending on the design:
 1. strip the protective tubes (2).
Secure the protective tubes to the rear panel with cable ties.
Route the bundled loose tube fibres into the protective tubes.
 2. Strip the corrugated tube (7).
Secure the protective tubes to the rear panel with cable ties.
Guide the bundled loose tube fibres into the corrugated tube.
- Feed the core of fibre cable through the opening on the rear of the rear panel and secure it with the clamping yoke screw (1). **Note:** see Fig. 22.
- Fasten the optical fibre mini cables / air cables (5) to the rear panel with cable ties (6).
- Bundle the protective tubes / corrugated hose / bundled loose tube fibres using guide rings (2) and route them via the cable diverter to the fibre tray level.

8.2 Loop

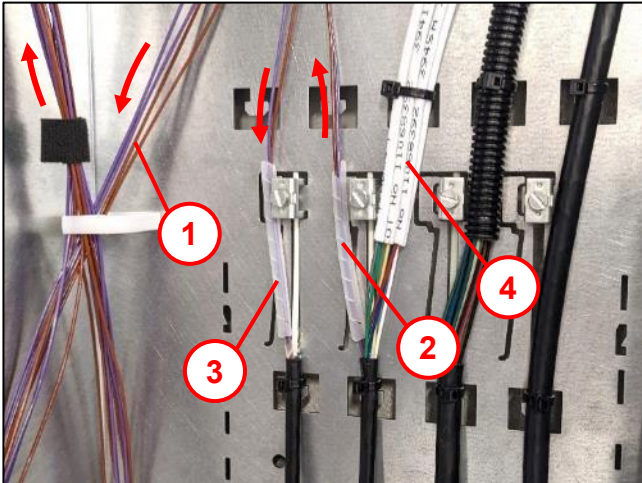

Fig. 24

- Fibres/bundled loose tube fibres to the excess cable tray (2).
- Outlet of the fibres (3) (bundled loose tube fibres/cables out of the cabinet).
- Bundled loose tube fibres via the cable diverter for loop excess storage (1).
Note: Lay excess length in a figure of eight.
- Cut fibres in bundled loose tube fibres to the fibre tray system level on the door (4).

8.3 Ongoing routing of optical fibre main cables / mini cables / bundled loose tube fibres

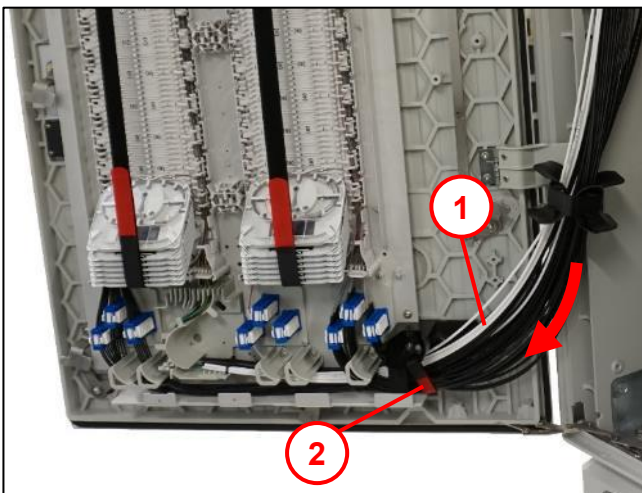

Fig. 25

- Continue routing the bundled loose tube fibres / corrugated hose / protective tube (1).
- Secure the cable harness with Velcro straps (2).

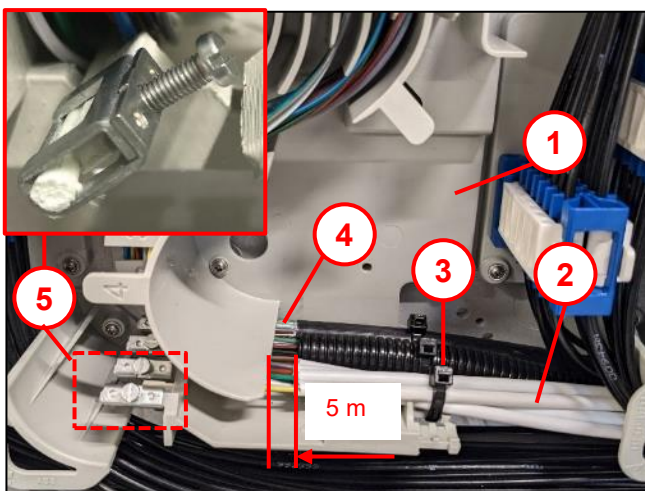

Fig. 26

- Depending on the design:
 - Attach the protective hose / corrugated tube (2) to the cable organiser (1) with cable ties (3).
 - Strip the protective hose / corrugated tube.
- Route the bundled loose tube fibres (4) into the cable organiser.
- Strip the core of fibre cable (5) to 70 mm.
- Insert the core of fibre cable into the bay, push on the clamping yoke and screw in place.
- Shorten the protruding core of fibre cable.

9 Installation of optical fibre micro cables

9.1 Inserting the micro cables / bundled loose tube fibres (on the rear panel)

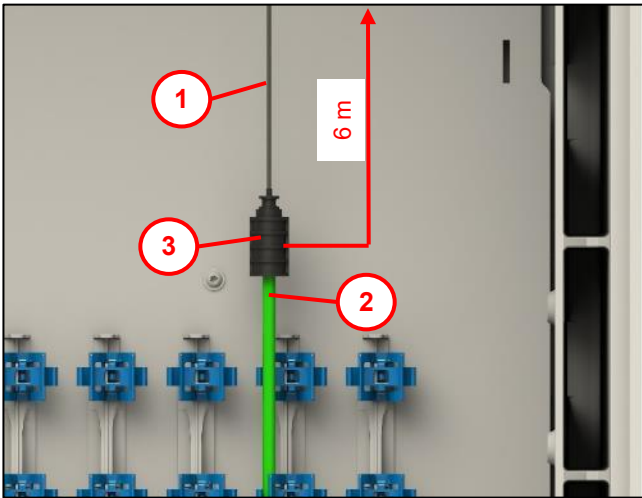

Fig. 27

- Insert the micro cables $\varnothing 2.5-4.0$ mm (1) into the micro-duct pipe (2).
Note: The length of the optical fibre micro cable must be, for example 6 m, from the cutting edge (depending on the specification).
- Seal the micro cables with sealing elements (3) (refer to manufacturer's installation instructions).

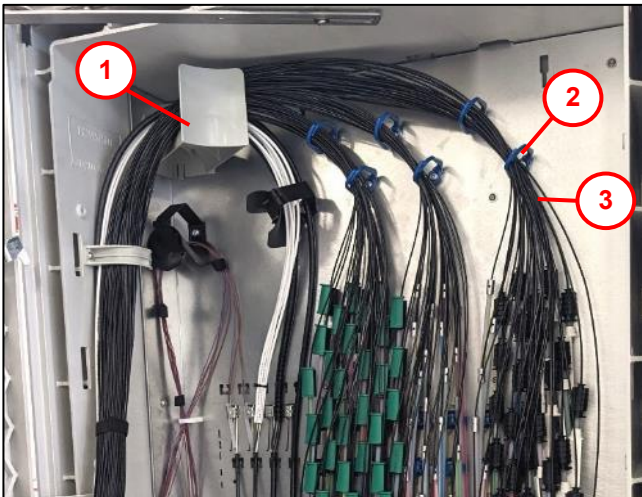

Fig. 28

- Route the optical fibre micro cables (3) through the guide rings (2) on the rear panel.
- Route the optical fibre micro cables via the cable diverter (1) and protective corrugated tube to the fibre tray level.

10 Inserting the optical fibre micro cables (at the fibre tray level)



Fig. 29

- The strain relief of the mini cable and organisation of the micro cables is done below the fibre tray management.

Note:

- Ensure loose routing around the optical fibre radius limiters when organising micro cables.
- The micro cable organisation shown below is for cable diameters of $\varnothing 2.5 - 4.0$ mm. Other micro cable classifications include:
 $\varnothing 1.3 / 1.8 / 2.5 / 2.8 / 3.5 / 3.8-4.0$

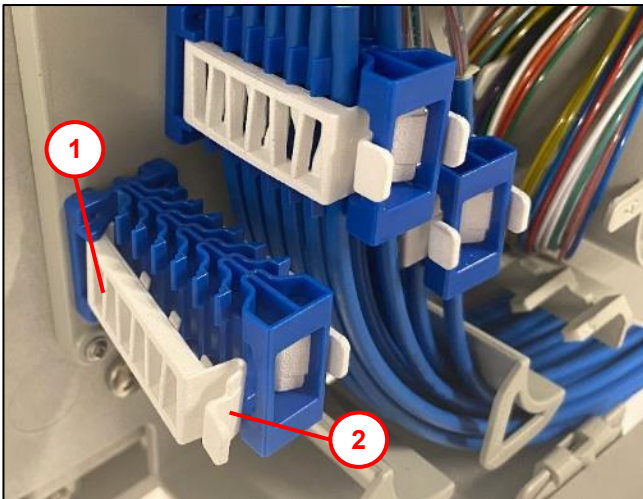

Fig. 30

- Remove the cover (1).
- Push the snap tab (2) backwards.
- Swivel the cover outwards and remove it.

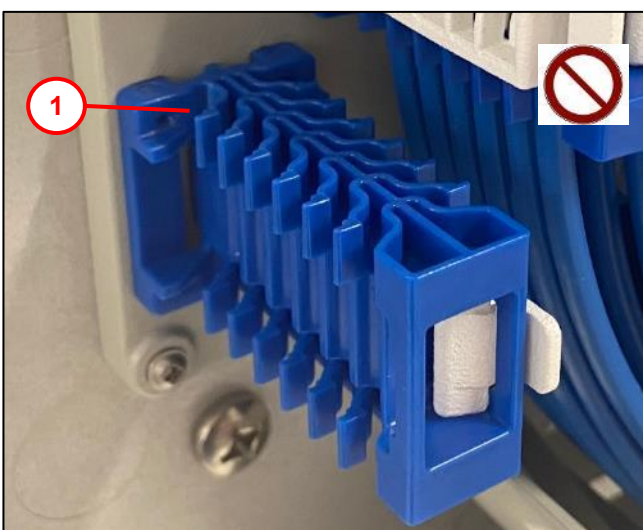

Fig. 31



Note: Leave the rear bay (1) unoccupied!

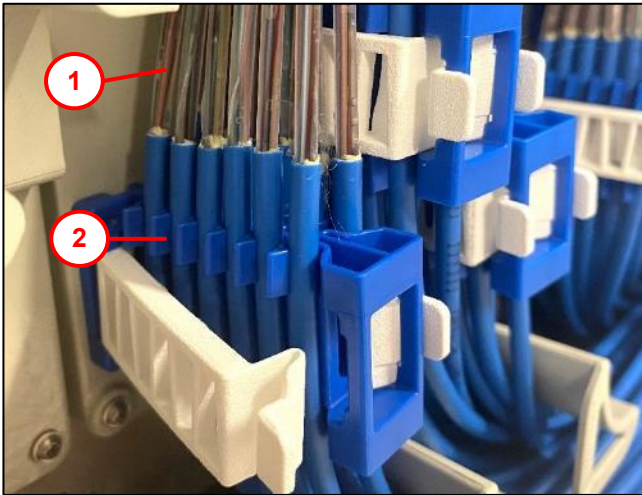

Fig. 32

- Press the micro cable (1) into the clamping positions (2), referring to Fig. 35 for the length to be stripped above the clamping positions.
Note: Start the assignment from the back to the front to simplify organisation.

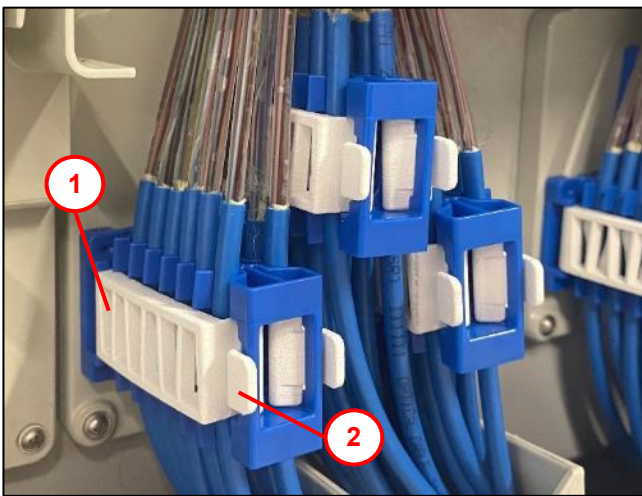

Fig. 33

- Insert the cover (1).
- Push the cover back and swivel it fully in until the snap tab (2) audibly clicks into place.

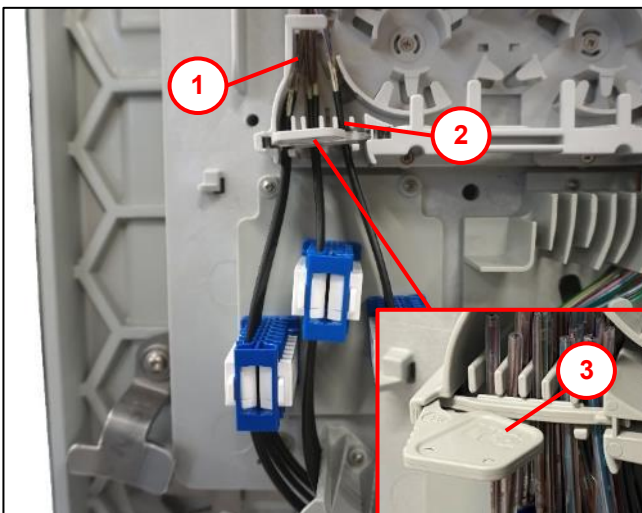

Fig. 34

- Strip the optical fibre micro cable (1) above the optical fibre guide duct (2) (see Fig. 35 for the length to be stripped).
- Use the fixing components (3) to fix the optical fibre micro cable in the optical fibre guide duct.

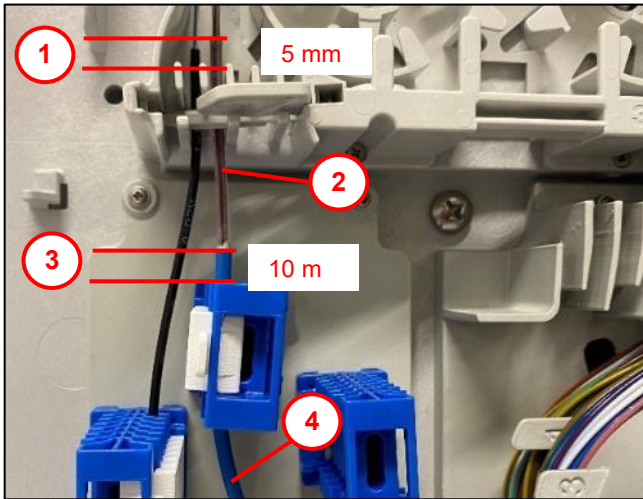

Fig. 35

- Strip the micro cable ≥ 3.0 mm (4) 10 mm above the clamping positions (3) up to the bundled loose tube fibres.
- Strip the bundled loose tube fibres approx. 5 mm above the optical fibre guide duct (1) and guide the optical fibres into the fibre tray management.
- Strip the micro cables < 3.0 mm 5 mm above the optical fibre guide duct (1) and route the optical fibres into the fibre tray management.

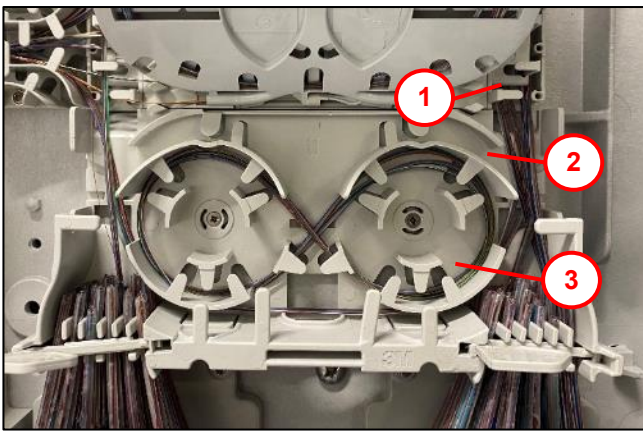

Fig. 36

- Change the fibre ducts (1) on the left - right within an end piece (2) and route the fibres over the fibre management spools.

11 Use of the protective cover

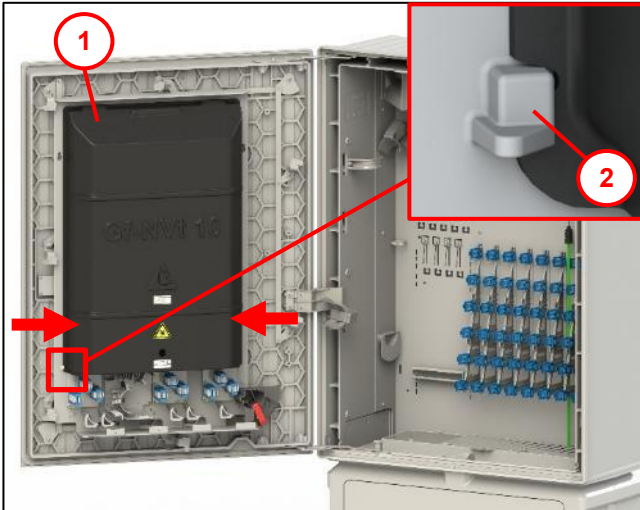

Fig. 37

- Press together the bottom of the protective cover (1) so that it detaches from the cover mounts (2).

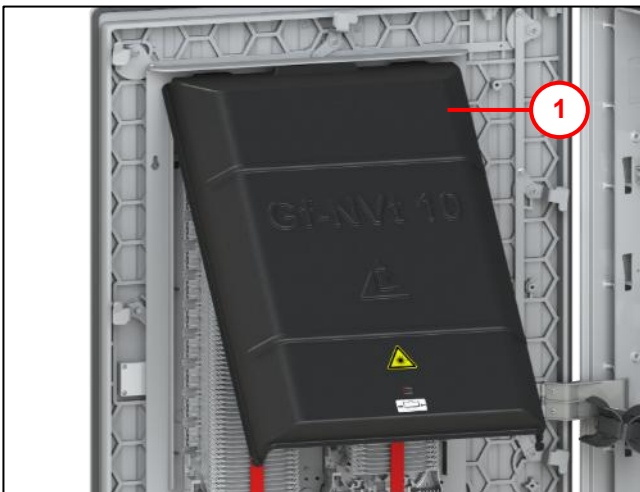

Fig. 38

- Pull the protective cover (1) slightly forwards and upwards out of the fastening clamp.

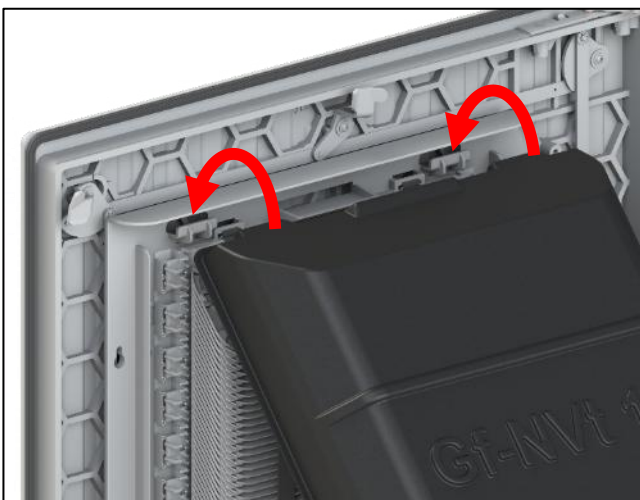

Fig. 39

The cover can be closed again in reverse order.

12 Description of the E&MMS fibre tray system

12.1 Organiser module (basic element)

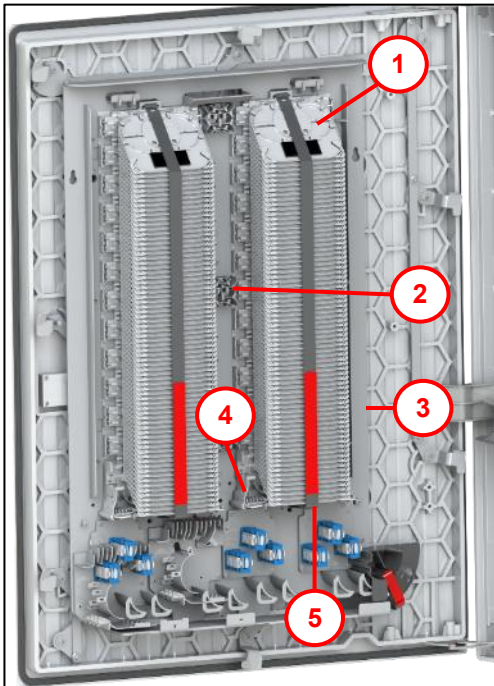

Fig. 40

- Item 1** Individual or multi-fibre trays
- Item 2** Fibre bridges cross switching
- Item 3** Organiser module (basic element) to hold fibre trays with fibre routing
- Item 4** Fibre entry area
- Item 5** Hook-and-loop fastener strap
Note: Slightly tighten and fix the Velcro strap.

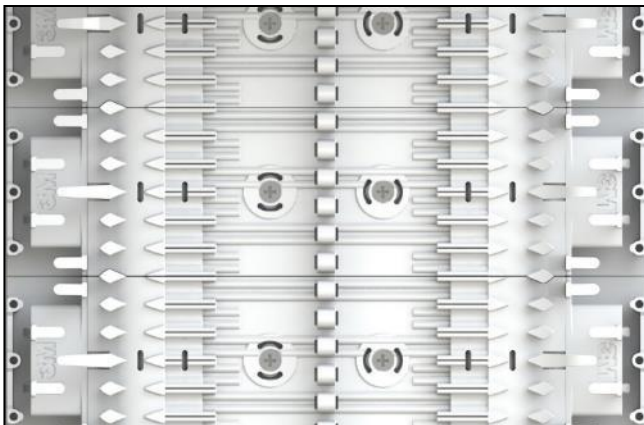

Fig. 41

The mounting level for the fibre trays in the FDC is modular in structure and consists of 12 individual modules per bay. Every module offers the option of accommodating up to 6x5 mm or 2x10 mm splice fibre trays (fibre trays are not included in the Langmatz scope of delivery). Every organiser module is screwed to the carrier plate. Fibre trays can be inserted and removed without tools. Total capacity 144x 5 mm fibre trays or 72x 10 mm fibre trays.

12.2 Description of the splice fibre tray

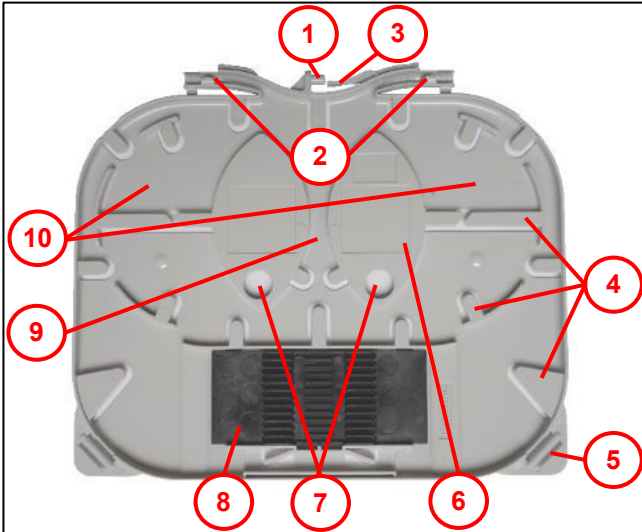

Fig. 42

- Item 1** Hinge pin
- Item 2** Fibre inlet / outlet
- Item 3** Securing lug
- Item 4** Down-holder for fibres
- Item 5** Mounting for marking rings
- Item 6** Mounting option for label
- Item 7** Mounting for cover
- Item 8** Insert for crimp splice protector
- Item 9** Change of direction guide
- Item 10** Excess cable tray / Inner fibre storage
- Item 11** Mounting option for coupler/splitter

12.3 Inserting fibre trays

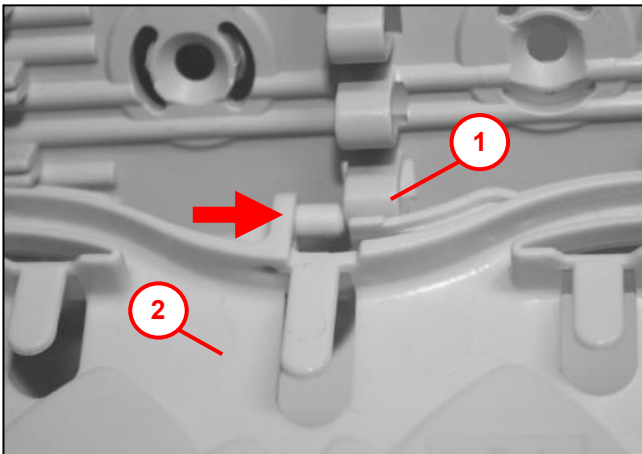

Fig. 43

- Position the fibre tray (2) at an angle of 90° on the slot (1).
- Push in from left to right with slight pressure.

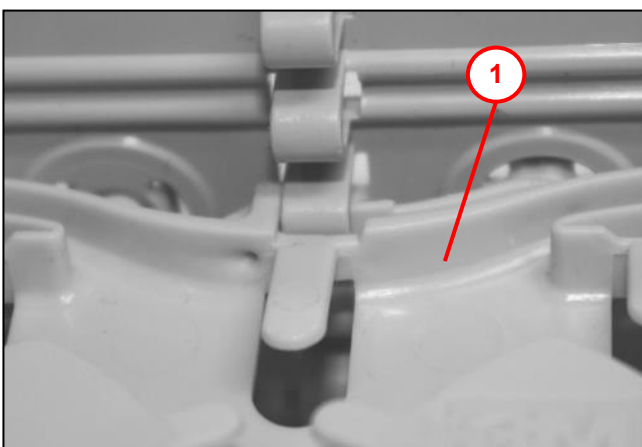

Fig. 44

- Insert the fibre tray (1) until it clicks into place.
- Fold the fibre tray down.

12.4 Removing the fibre tray

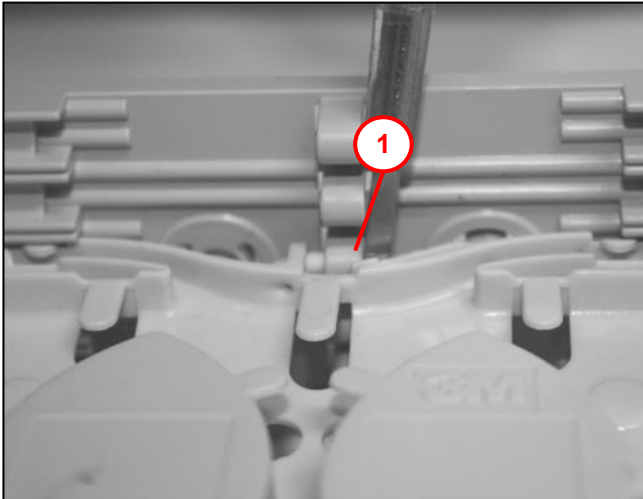

Fig. 45

- The securing lug (1) is moved to remove the fibre tray.
- Next, slide the fibre tray to the left out of the mount.

12.5 Splicing fibres

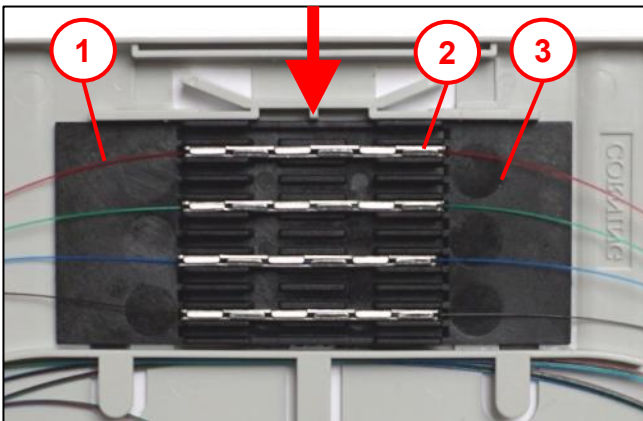

Fig. 46

- Determine the fibre lengths. (Minimum length to the exit from the organiser module for three reserve coils approx. 1600 mm plus the excess length for the fibre separator).
- Splice fibres (1).
- Starting from the top, strip the splice protector (2) in the splice protector holder (3).

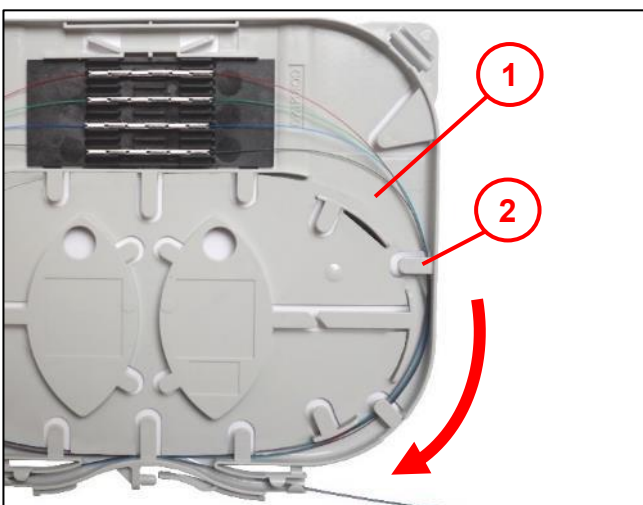

Fig. 47

- Insert and guide the fibre bundle (right or left) into the outer fibre duct (1) under the down-holder (2).

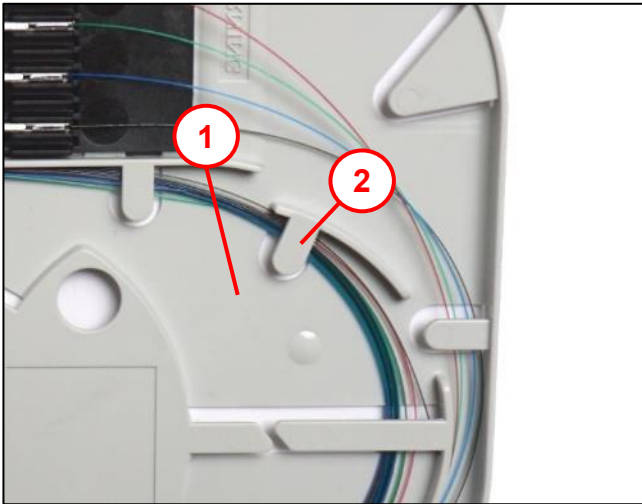

Fig. 48

- Insert fibres into the inner fibre tray (1) and insert several fibre coils.
- Note:** It is not necessary to thread the fibres into the down-holders (2). They can be pushed under them by exerting minimal pressure on the flexible large down-holders.

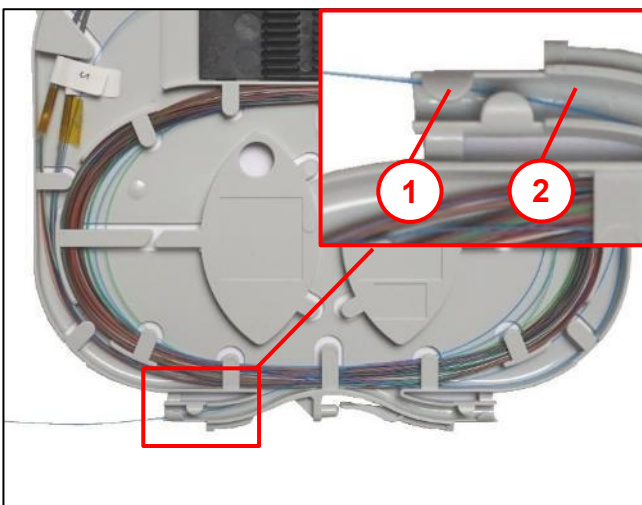

Fig. 49

- Route the remaining fibres away via the fibre inlet/outlet duct (2).
- To do this, carefully pry the fibres under the small down-holders (1) at the inlet/outlet duct with small bending movements.
- Free the fibres without kinking them, and guide them to the side via the organiser module – do not transgress the bending radius.

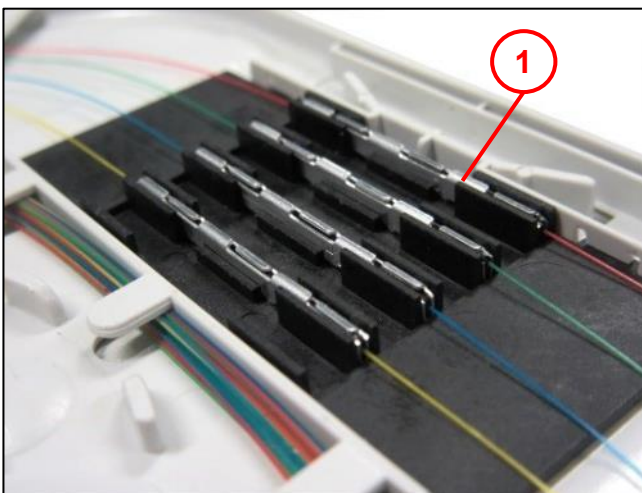

Fig. 50

- Proceed in the same way with the second fibre bundle.
- Check whether all the fibres are in the ducts and correctly under the down-holders (1) (check by brushing a flat hand over the fibre tray that all fibres are correctly placed in the appropriate trays).

12.6 Keeping fibres in reserve

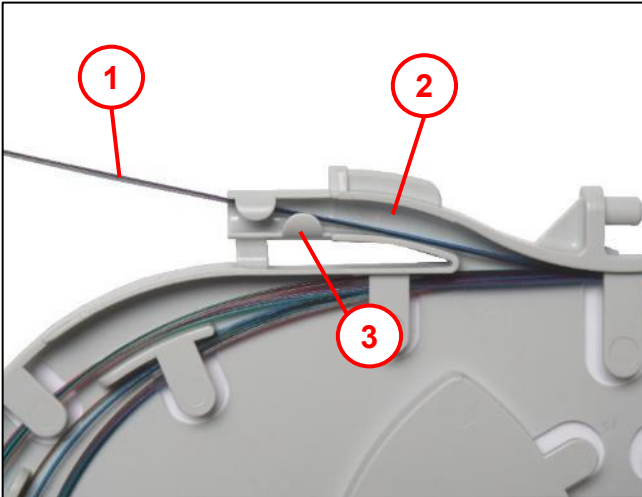

Fig. 51

- Insert fibres (1) into the fibre inlet duct (2) of the fibre tray.
- To do this, carefully pry the fibres under the small down-holders (3) at the inlet/outlet duct with small bending movements.

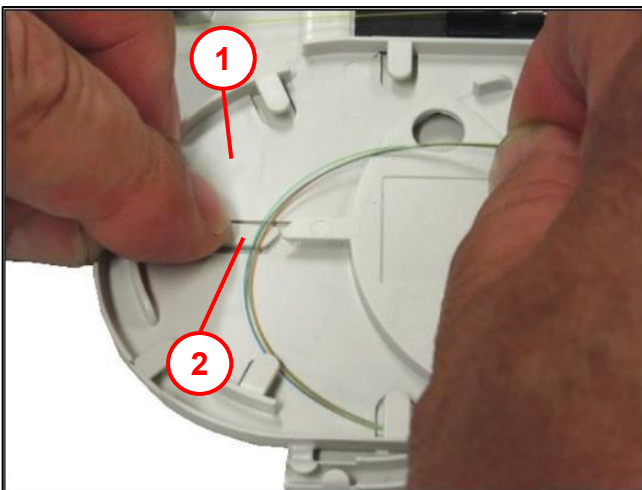

Fig. 52

- Insert fibres into the inner tray (1) of the fibre tray.
- Store completely in multiple coils.
Note: It is not necessary to thread the fibres into the down-holders (2). They can be pushed under them by exerting minimal pressure on the flexible large down-holders.

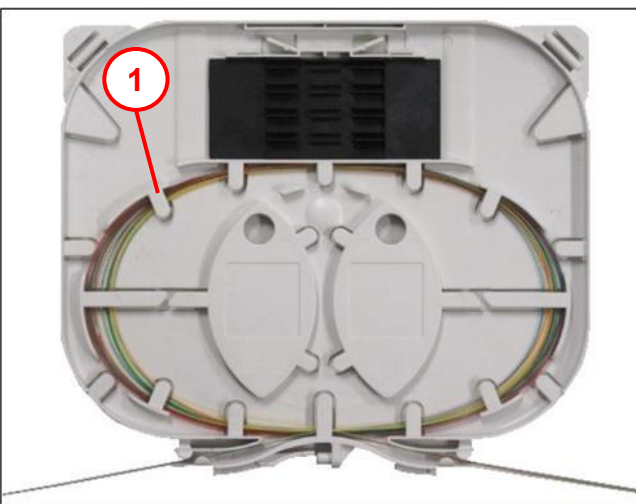

Fig. 53

- Proceed in the same way with the second fibre bundle.
- Check whether all the fibres are in the ducts and correctly under the down-holders (1) (check by brushing a flat hand over the fibre tray that all fibres are correctly placed in the appropriate trays).

12.7 Changing the direction of the fibres

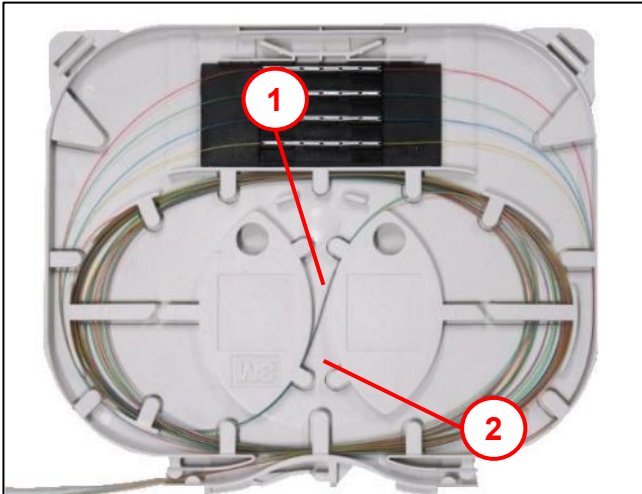

Fig. 54

- Insert fibres (1) into the fibre duct in the central fibre tray area (2).

12.8 Optical fibre entry port

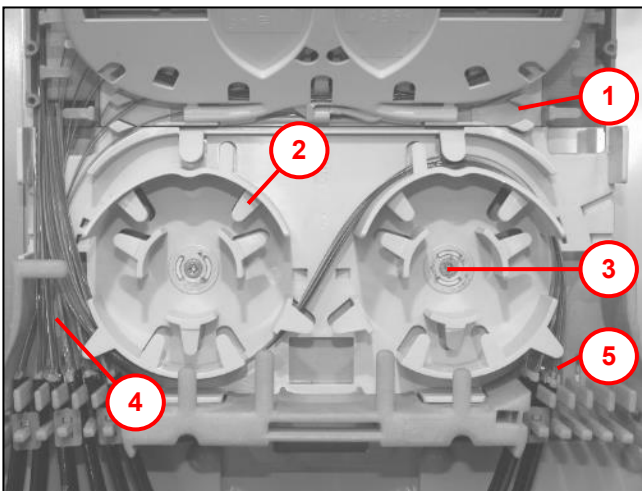

Fig. 55

The end piece for the optical fibre entry port (3) is located under the first fibre tray carrier (1).

Its purpose is to bring the individual micro cables (5) and bundled loose tube fibres (4) together, to fasten them and, if necessary, to change the routing from the right side to the left side via the fibre management spools (2).

12.9 Side optical fibre cable guide

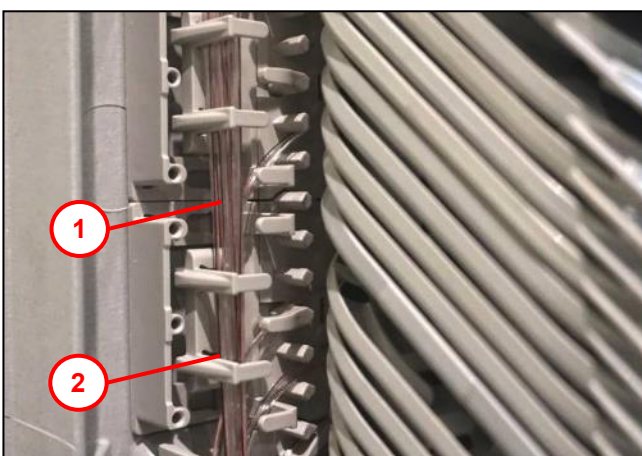

Fig. 56

There are guides on the left and right sides of the fibre tray carrier for structured routing of the optical fibre cables.

The guides have two levels one on top of the other.

Optical fibres that run over a length of more than 12 fibre trays are routed in the lower level (1) and only laid on the upper level (2) before entry.

12.10 Inserting the optical fibres into the fibre tray

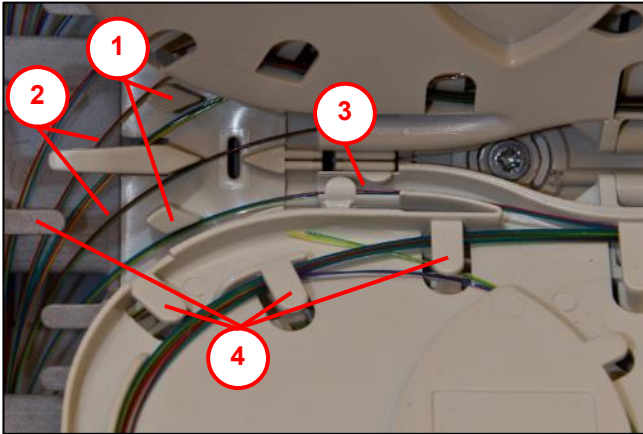

- To ensure the minimum bending radii, the optical fibres (2) are routed along the guide elements (1).
- When they enter the fibre tray, the optical fibres are inserted into the fibre feed (3). The fibre feed is sized in such a way that the optical fibres are not damaged when the fibre tray is folded.
- Down-holders (4) prevent the optical fibres from popping out.

Fig. 57

Example of fibre routing in fibre trays



Fig. 58

Storing the fibres in the excess length storage.

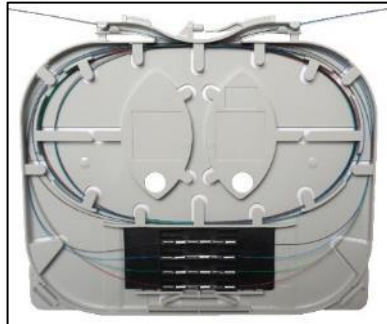

Fig. 59

Fibre guiding of the splice storage.

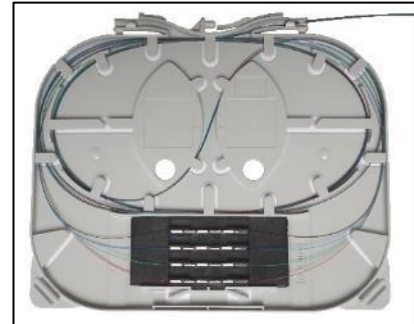

Fig. 60

Fibre guiding during changes of fibre directions.

12.11 Optical fibre bridge



Fig. 61

- There are 3 single-fibre bridges between the rows of fibre trays for manoeuvring between the two fibre tray stacks.
- Bridges provide the necessary protection and ensure the minimum bending radius of the fibres.

12.12 Brackets

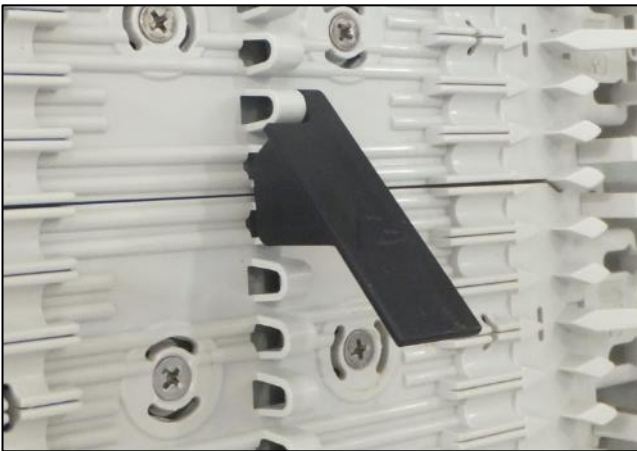

Fig. 62

- Brackets for supporting fibre trays that are not supported by an underlying fibre tray
- Insert the bracket into the underlying fibre tray holder

12.13 Attaching and removing the fibre tray cover



Fig. 63

- The top fibre tray is fitted with a transparent cover (1) to protect the fibres and splices.
- All other fibre trays are protected by the respective fibre tray above.

13 Assembly and disassembly for cabinet replacement

Note:

- If only the door needs to be replaced, continue with 13.4.
- Two people are required to replace the cabinet and door

13.1 Removing the earthing

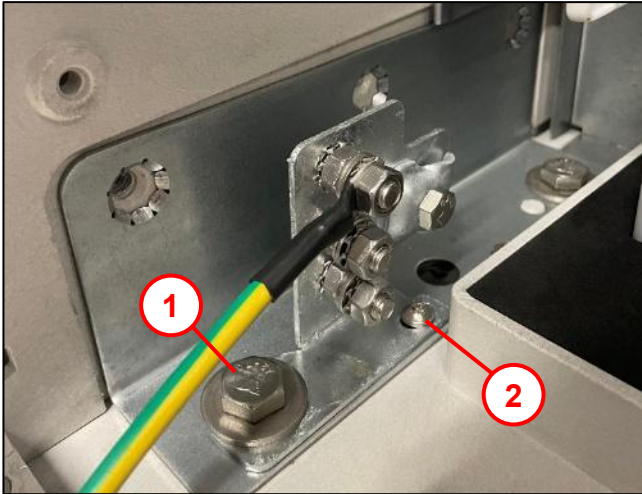

Fig. 64

- Remove earthing (if fitted).
- Slightly loosen 1x hex screw M10x50 (1) with an AF19.
- Remove 1x fastening screw 5x12 (2) with a Torx TX25.

13.2 Removing the rear panel

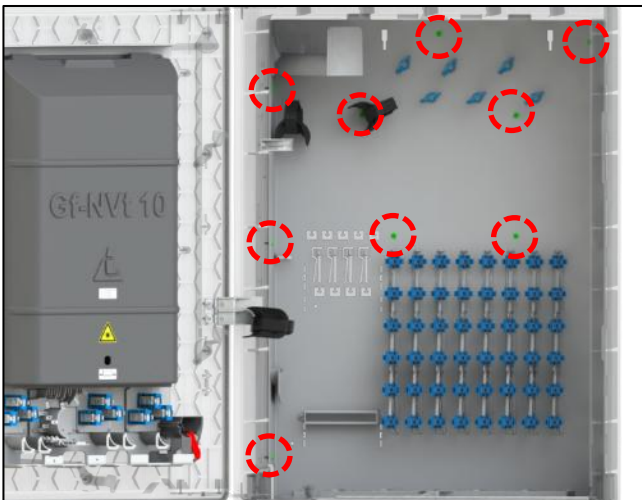

Fig. 65

- Remove 9x thermoplastic screws K60x16 with a Torx TX25.

13.3 Removing the brackets

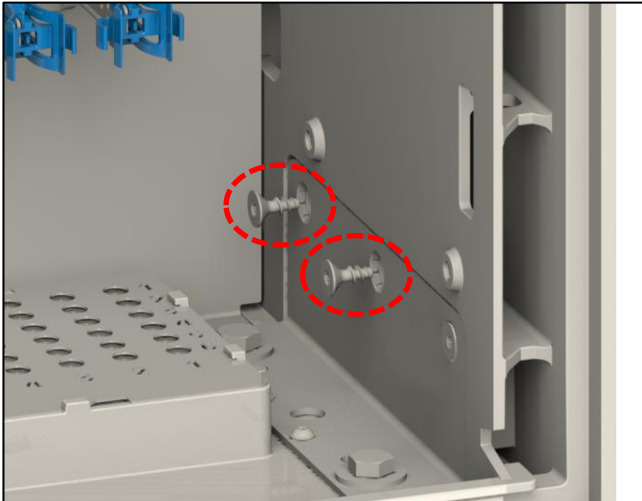

Fig. 66

- Remove 2x thermoplastic screws 80x20 at the back for each bracket (left and right) with a Torx TX40.

13.4 Removing the cable routing



Fig. 67

- Remove the cable routing (1).
- Remove 1x thermoplastic screw plus 50x12 with a Torx TX25.

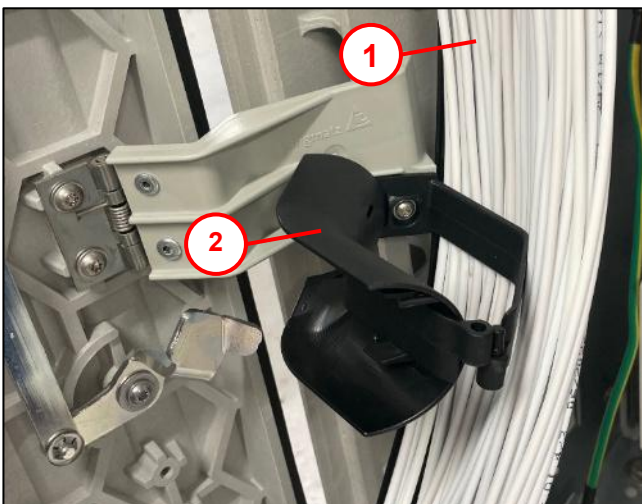

Fig. 68

- Loosen the cable (1) from the cable routing (2).
- Bundle cables with Velcro straps if possible.

13.5 Loosening the mounting panel

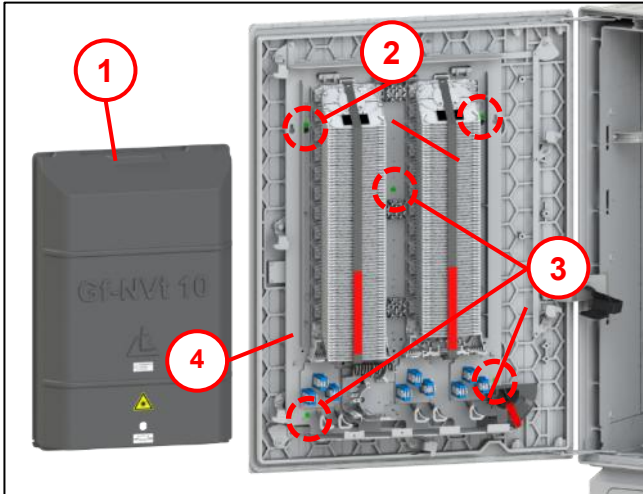

Fig. 69

- Remove the cover (1), referring to section 11.
- Slightly loosen 2x thermoplastic screws K60x16 (2) with a Torx TX25.
- Remove 3x thermoplastic screws K60x16 (3) with a Torx TX25.
- Detach the mounting panel (4) via the key holes upwards.

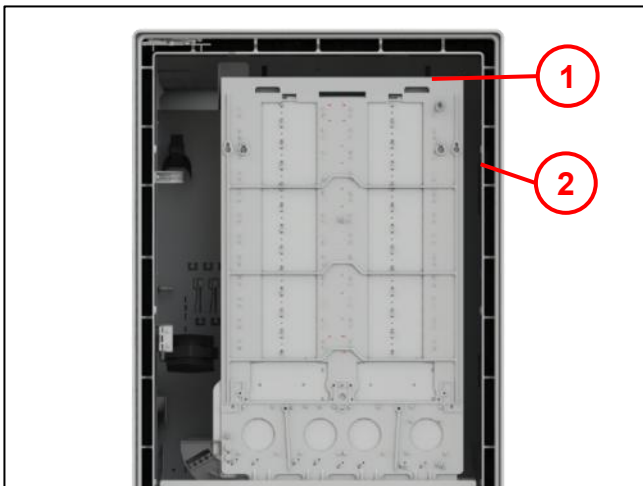

Fig. 70

- Position the mounting panel (1) in the cabinet (2).

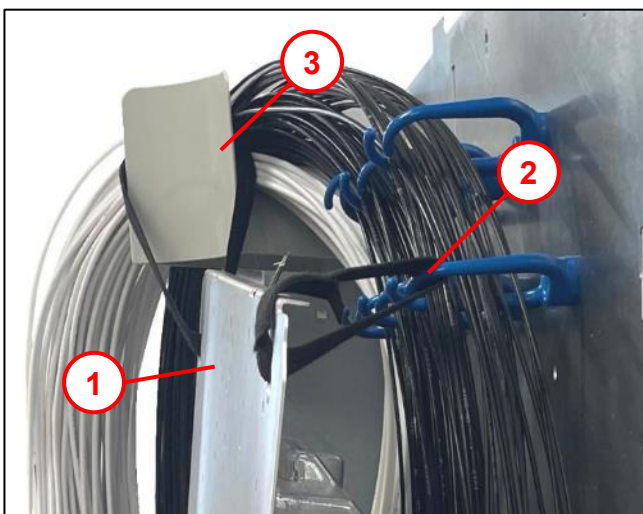

Fig. 71

- Attach the mounting panel (1) to the guide ring (2) and cable diverter (3).

13.6 Releasing the door

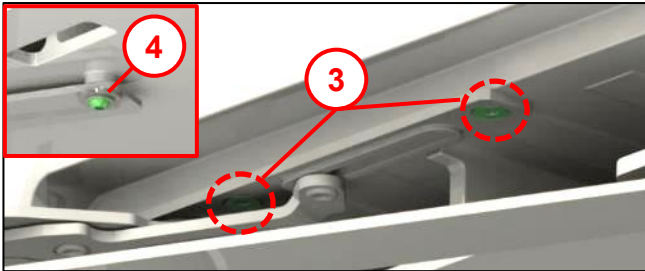
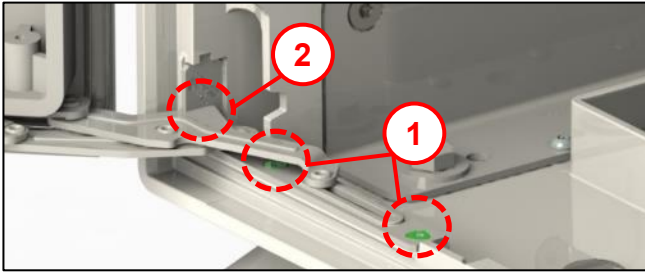

Fig. 72

- Remove the door.
- Loosen 2x thermoplastic screws 50x16 **(1)** with a Torx TX25 on the lower door hinge.
- Loosen 2x thermoplastic screws 50x16 **(2)** with a Torx TX25 on the lower door hinge.
- **Note:** The door must be closed slightly for this!
- Loosen 2x thermoplastic screws 50x16 **(3)** with a Torx TX25 on the upper door hinge.
- Loosen 1x screw **(4)** with a Torx TX25 on the door adjuster.

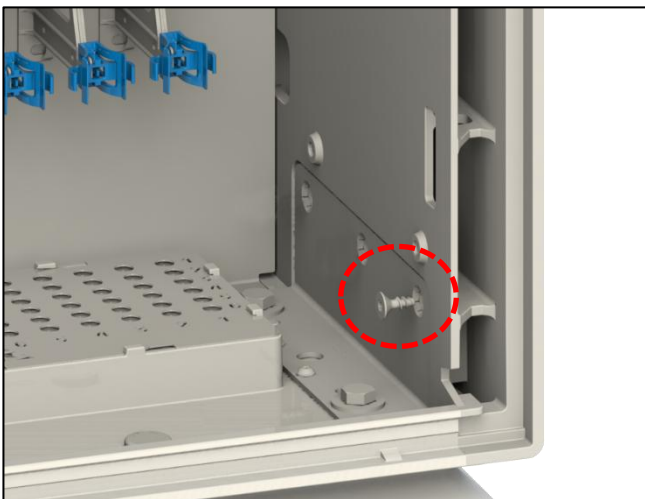

Fig. 73

- Remove 1x thermoplastic screw 80x20 at the front on each bracket (left and right) with a Torx TX40.

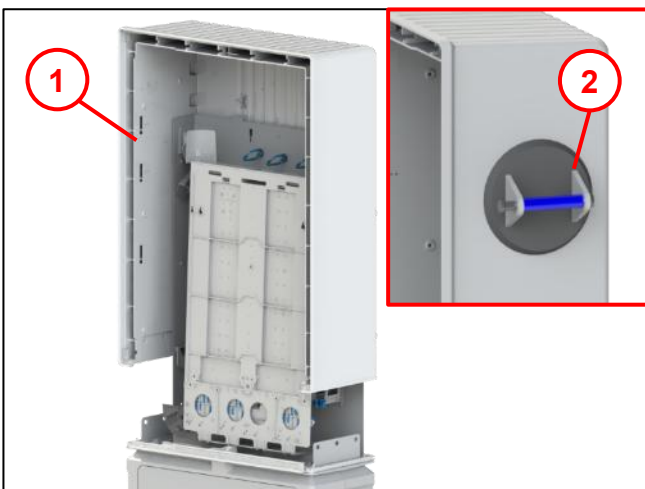

Fig. 74

- Carefully lift the cabinet **(1)** upwards using the installation kit.
- **Note:** An appropriate suction lifter **(2)** can be used to lift the cabinet.
- Place the new cabinet on the pedestal and reinstall the door hinges as shown in Fig. 72.

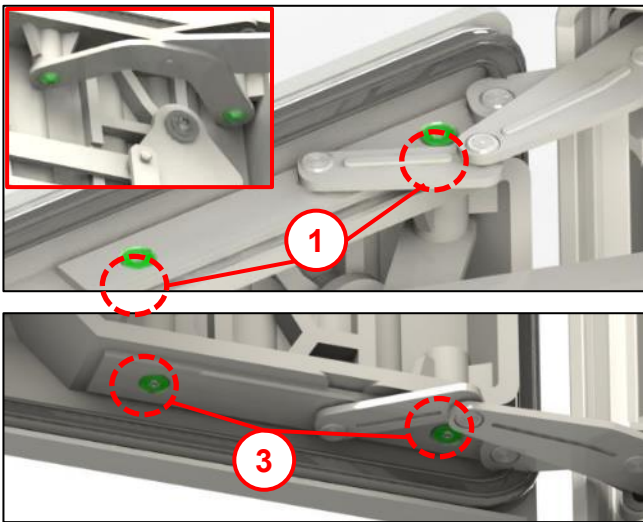

Fig. 75

- Attach the door hinges to the door with 2x thermoplastic screws 50x16 at the top **(1)** and 2x thermoplastic screws 50x16 at the bottom **(2)** using a Torx TX25.

Then perform Figs. 65 to 74 in reverse order.

14 Double swivel lever

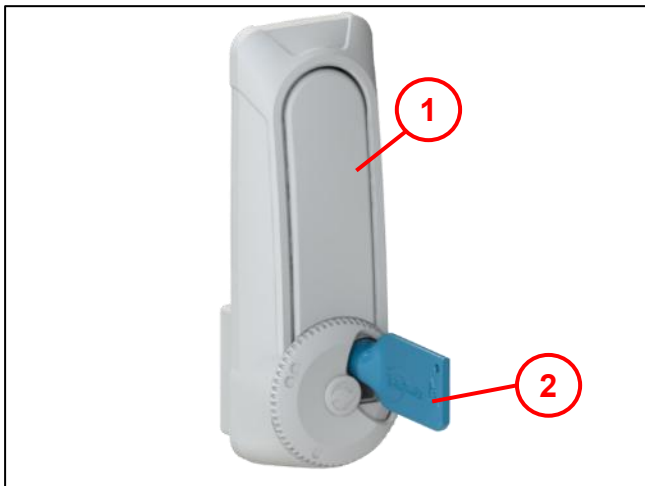

Fig. 76

- Open the swivelling lever handle **(1)** with the cabinet/manhole key **(2)**.



Fig. 77

- Insert the profile half-cylinder **(2)** from the rear or from the front (depending on the make) into the swivel lever handle **(1)**.
- Adjust the depth of the profile half-cylinder until the fastening screw **(3)** can engage in the thread.
- Tighten the fastening screw.

Note: A blind cylinder can be used with a double swivel lever if a profile half-cylinder opening is temporarily not used (usually factory installed).

See also the EMKA installation instructions:
https://www.emka.com/de_en/vlink-0000000063



15 Earthing kit (accessory)

15.1 Earthing kit

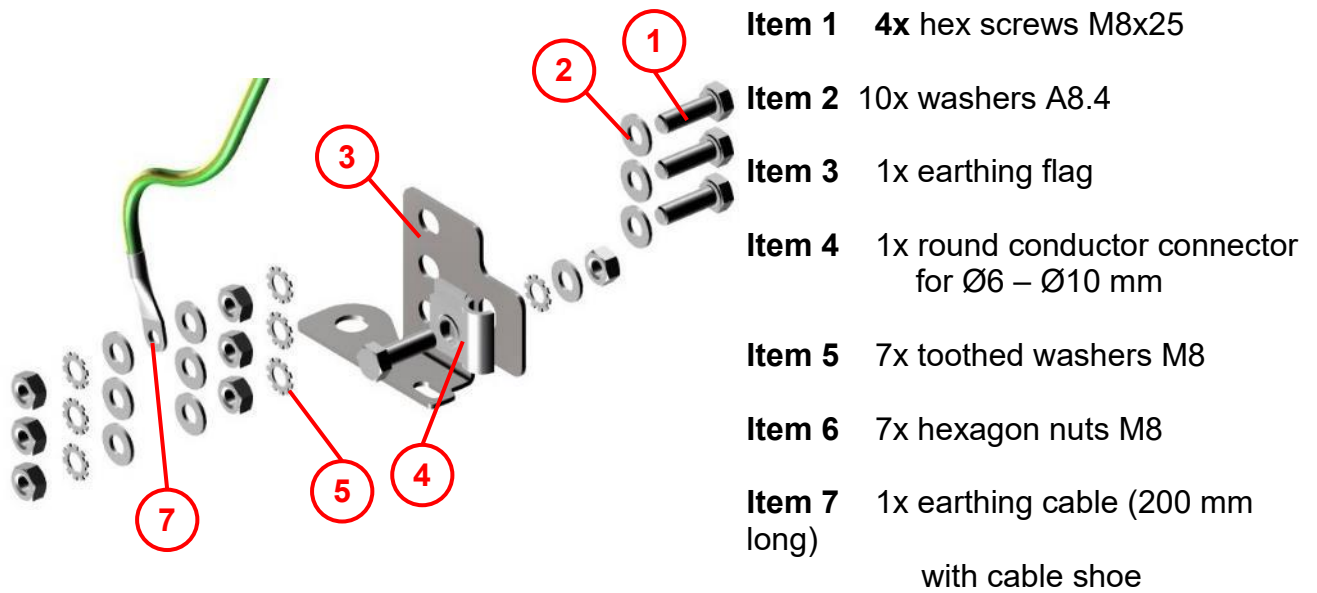

Fig. 78

15.2 Preparation

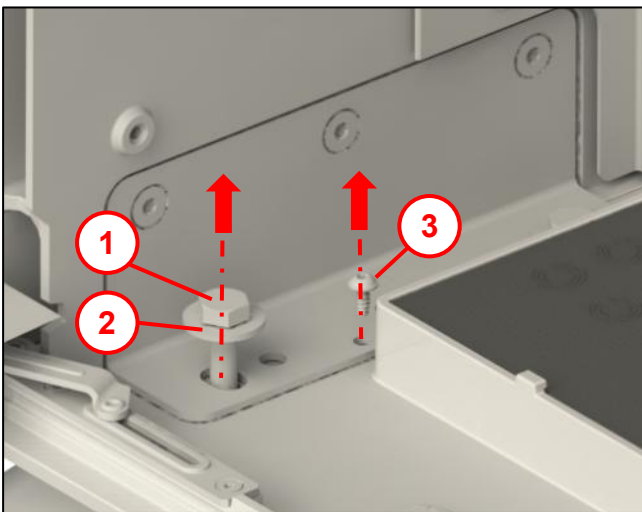

Fig. 79

Remove from the base plate (front left in the KVz22):

- 1x hex screw M10x50 (1), 1x washer (2), 1x fastening screw for plastic 5x12 (3)

15.3 Pre-assembly of the earthing flag

15.3.1 Installation of the earthing cable (1x)

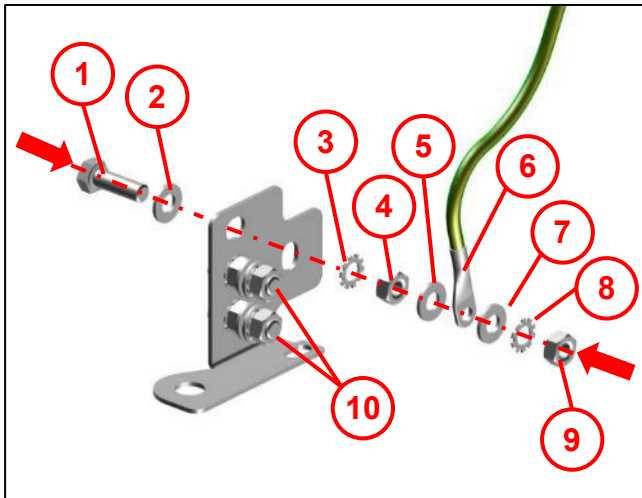

Figure 80



Note the sequence!

- **Rear:**
 - 1 Fit 1x hex screw M8x25 with
 - 2 1x washer.
- **Front:**
 - 3 Fit 1x toothed washer M8;
 - 4 1x hexagon nut M8;
 - 5 1x washer A8.4;
 - 6 1x earthing cable;
 - 7 1x washer A8.4;
 - 8 1x toothed washer M8;
 - 9 1x hexagon nut M8.

Pre-assemble the screw connections for the second and third earthing cable (**10**) as described.

15.3.2 Installation of the cable holder for Ø6 mm - Ø10 mm

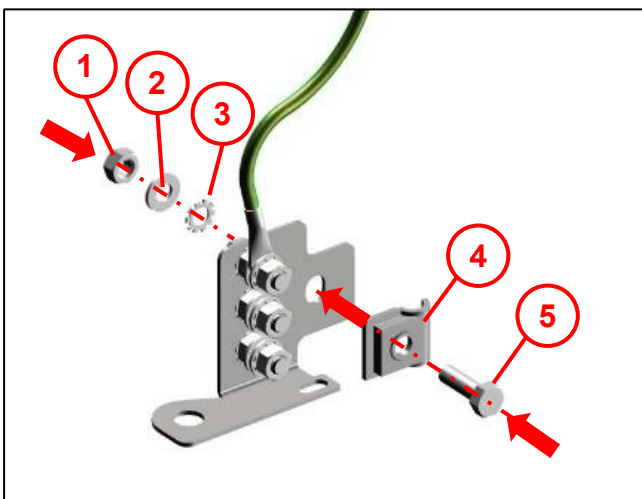

Fig. 81



Note the sequence!

- **Rear:**
 - 1 Fit 1x hexagon nut M8;
 - 2 1x washer A8.4;
 - 3 1x toothed washer M8.
- **Front:**
 - 4 Fit 1x round conductor connector for Ø6 mm – Ø10 mm
 - 5 1x hex screw M8x25

15.4 Installing the earthing flag in the KVz22

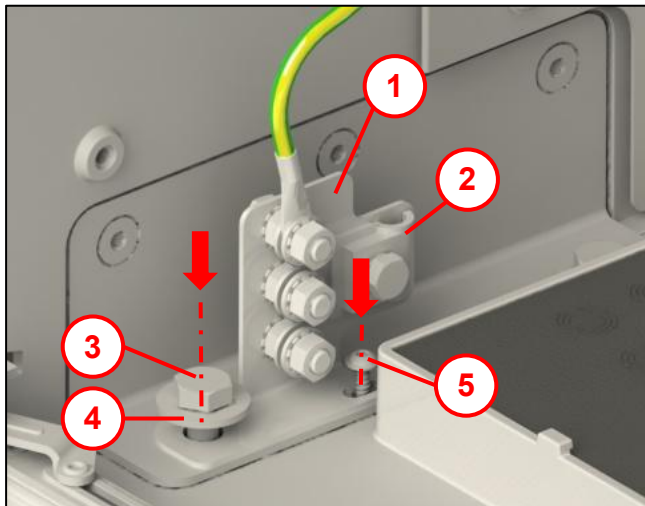

Fig. 82

- Insert the complete earthing flag **(1)** in the KVz22.
- Fit the screws previously removed (see Fig. 3) on the base plate.
 - 1x hex screw M10x50 **(3)**.
 - 1x washer **(4)**.
 - 1x fastening screw for plastic 5x12 **(5)**.
- Fix the earthing cable in the round conductor connection **(2)**.

16 Order data and accessories

Refer to the Product Catalogue for FTTX Optical Fibre Networks:

<https://langmatz.de/de/produkte/outdoorgehaeuse/glasfaser>

17 Material defects

Langmatz accepts liability for material defects in the product as per Section 434 BGB (German Civil Code) for 24 months, starting from the date on the purchase receipt.

Within the scope of liability, all parts that become damaged due to manufacturing faults or material defects will be replaced or repaired free of charge.

The purchaser must report any deficiency complaints immediately in writing.

Claims by the purchaser for damages due to material defects or for whatever legal reason will not be accepted.

Any damage or failure caused by the following are also excluded from liability:

incorrect use,

natural wear and tear,

intervention by third parties.

We accept no liability for damage caused by force majeure or transport.

Repairs due to a complaint about a defect do not extend the warranty period for the replaced parts or for the product.

This product conforms to the latest state-of-the-art technology. Nevertheless, if you experience any problems with it, please contact our hotline (chapter 20).

18 Recycling

The materials mainly used for the optical fibre distribution cabinet are polycarbonate and ABS and are fully recyclable.

19 Cleaning, repainting

Normally soiled cabinets can be cleaned with standard household cleaning agents.

The cabinets can be coated with a two-component paint on site.

20 Quality management

Langmatz GmbH's quality management system is certified according to DIN EN ISO 9001.

21 Disclaimer/Warranty

The information in this technical document is presented appropriately and correctly in compliance with the technical regulations, and to the best of our knowledge. However, this does not confer any guarantee of particular characteristics. In this context, the company that operates the products supplied by Langmatz GmbH is expressly obliged to decide, based on its own judgement, whether the products are suitable and appropriate for the application or use being considered. The product liability accepted by Langmatz GmbH relates exclusively to our conditions of sale, delivery, and payment. Langmatz GmbH accepts no liability on the basis of random, indirect and resultant consequential damage, or of any damage attributable to any use of the product other than its intended purpose as described.

22 Contact

Langmatz GmbH | Am Gschwend 10
82467 Garmisch-Partenkirchen, Germany

Our hotline: +49 88 21 920 – 137

Phone: +49 8821 920 - 0

Email: info@langmatz.de | www.langmatz.de

