

Installation Instructions

DC polycarbonate foundation for EK980 charging columns



Contents

1	General information	4
2	Safety information	4
3	Product description	5
	3.1 Dimensions	5
	3.2 Technical data	5
4	Package includes	6
	4.1 Required tools (not included)	7
	4.2 Tightening torque table	7
5	Foundation pit base	8
	5.1 General	8
	5.2 Preparing the foundation pit base	8
	5.3 Installation situations	9
6	Installation – Polycarbonate foundation with base plate/adapter plate	10
	6.1 Constructing the base	10
	6.2 Dismantling the base plate and adapter plate	10
	6.3 Removing the predetermined breaking points for cable ducts	11
	6.4 Fitting the stepped grommet	11
	6.5 Optional: Installing a strain relief rail	12
	6.6 Backfilling the foundation pit	12
	6.7 Height adjustment	13
	6.7.1 Adjusting the height at the steel frame	13
	6.7.2 Filling the foundation pit and free space	13
	6.8 Installing the base plate and adapter plate	14
7	Installing the charging column (not included in delivery)	15
	7.1 Opening the screw connection	15
	7.2 Earthing requirement	15
	7.3 Example of earthing with a rebate clamp (not supplied)	15
	7.4 Installing the charging column	16
8	Optional installation – Polycarbonate foundation with cast-iron cover	17
	8.1 Installation of the polycarbonate foundation	17
	8.2 For installation of the charging column – Dismantling the cast-iron cover	17
	8.3 Set – Installing the base plate/adapter plate	17
9	Optional installation – Cast-iron cover as a retrofit kit	18
	9.1 Installation of fixings	18
	9.1.1 Screw locks 1	18
	9.1.2 Screw locks 2	18

9.2	Installation of the cast-iron cover	19
9.2.1	Inserting the damping pad	19
9.2.2	Inserting the cast-iron cover	19
10	Maintenance	20
11	Accessories	20
12	Material defects	21
13	Quality management	21
14	Disclaimer/Warranty	21
15	Contact	21

1 General information

These instructions are included with delivery.



Warning!

Any person involved in the installation, operation and repair of the product must first read, understand and follow these instructions. We accept no liability for damage and operating malfunctions caused by failure to comply with these instructions.

In the interest of further development, we reserve the right to change individual assemblies and accessories as considered necessary for further safety and performance improvements, while preserving the main features.

The copyright to these instructions remains with Langmatz GmbH.

2 Safety information

The polycarbonate foundation is designed for stationary use underground as

- anchors for charging columns,
- cable draw manholes,
- telecommunication distribution points/fibre distribution points,
- energy distribution systems,
- systems to accommodate electronic components.

Where the polycarbonate foundation is used to accommodate electronic components, it is not suitable for use in explosive atmospheres.

The product complies with the latest state-of-the-art technology at the time of printing and is delivered in an operationally safe condition. Unauthorised modifications, particularly to safety-related parts, are prohibited.

Langmatz GmbH warns against the misuse of the product.

Work on electrical or electronic fixtures may only be performed by qualified electricians.

The operating company is responsible for installing, operating and maintaining the fixtures.

The operating company is responsible for the following:

- Preventing danger to the life and limb of users and third parties.
- Ensuring operational safety.
- Preventing downtime and environmental impact caused by incorrect handling.
- Ensuring that protective clothing is worn when working with or on the product.



Do not use the product if it is damaged. Please contact the hotline (see section 15).



Warning!

Comply with applicable occupational safety and environmental protection regulations during installation, operation, maintenance, and repair.

3 Product description

Since Langmatz polycarbonate foundations come in a wide variety of sizes and versions, these instructions are based on one product by way of example with clear dimensions (CD) of 650 x 800 mm and 650 mm high.

Declared / assumed service life

3.1 Dimensions

(Product example CD 650 x 800 mm)

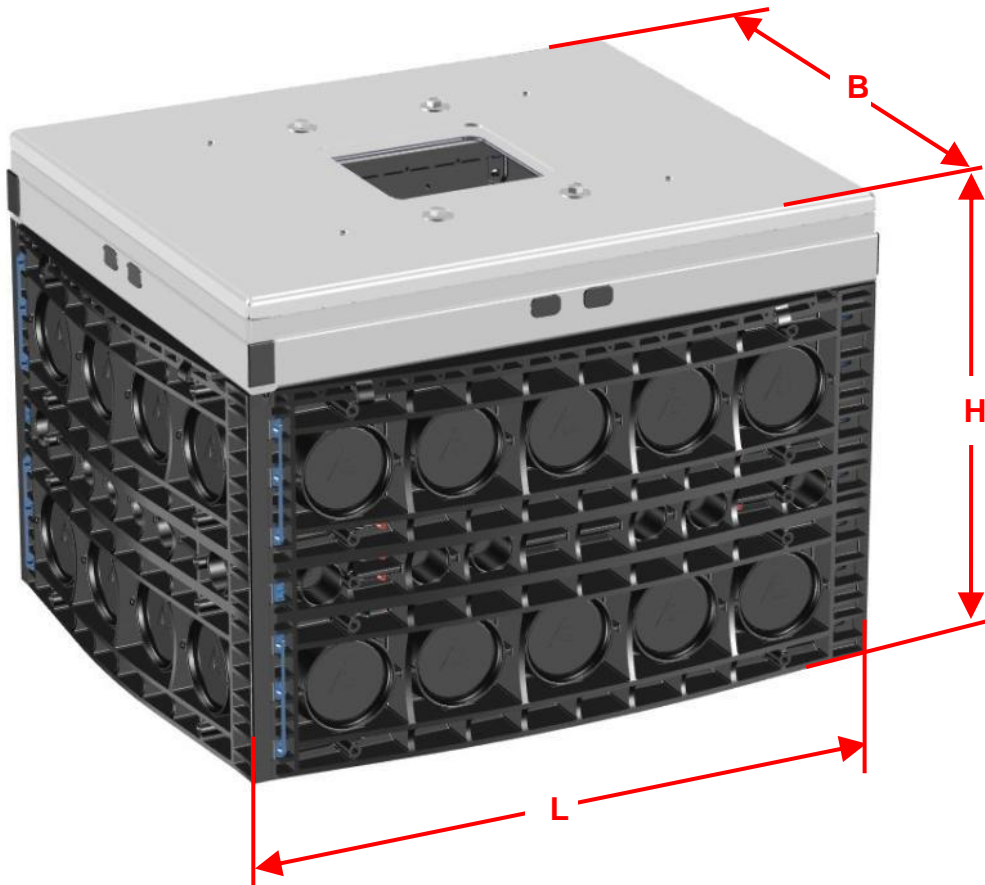

Fig. 1

3.2 Technical data

Dimensions L x W x H:	950 x 810 x 650 mm
Total weight	Approx. 110 kg
Frame component material	Polycarbonate (PC)
Metal parts material:	Galvanised steel/coated steel
Screw connection material:	Stainless steel
Max. load capacity of the adapter plate	1800 kg
Max. charging column dimensions	Height 2500 mm / Width 900 mm
Minimum charging column weight	200 kg

4 Package includes

(Example shows product CD 650 x 800 mm/H 650 mm)

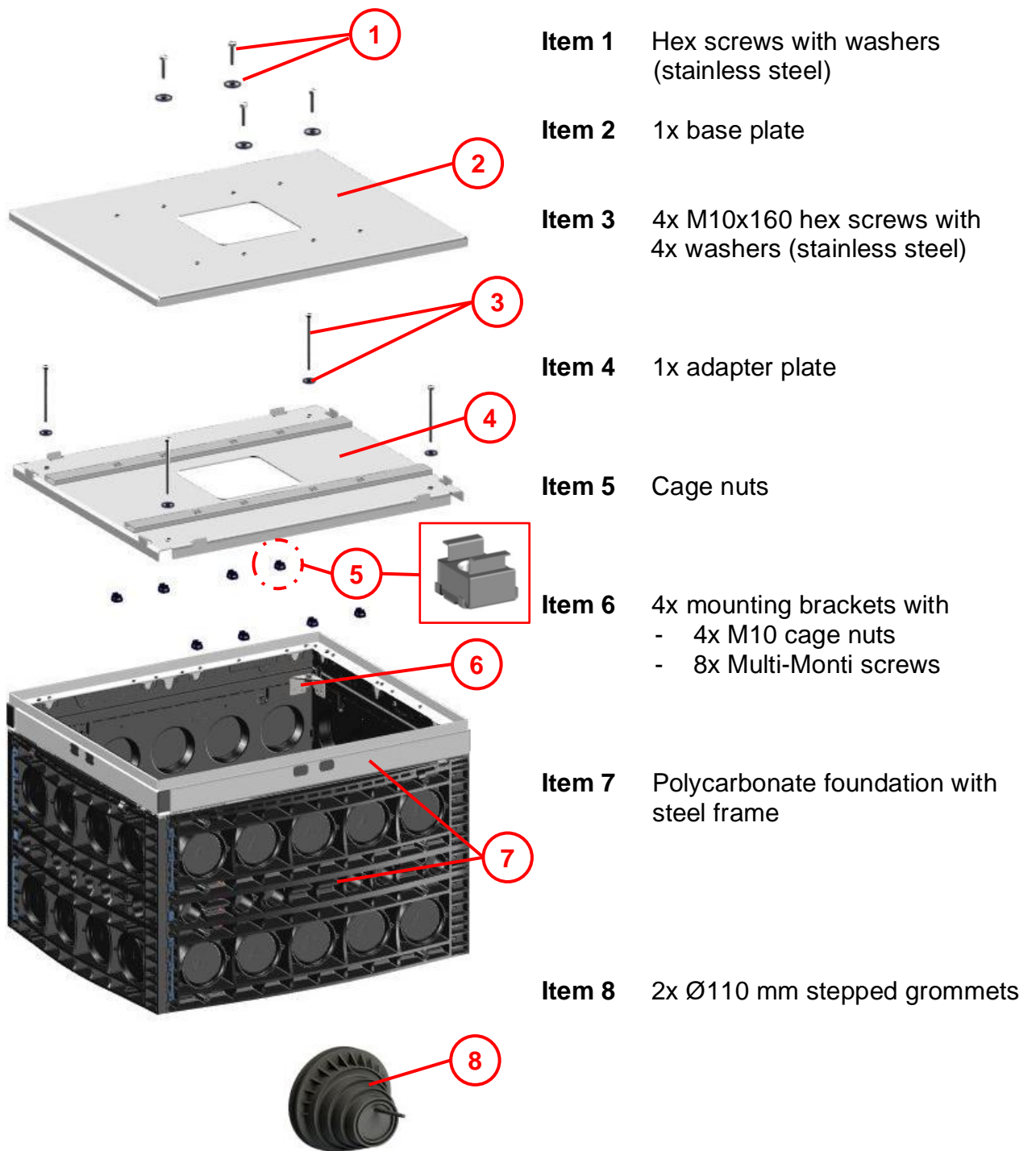

Fig. 2

4.1 Required tools (not included)

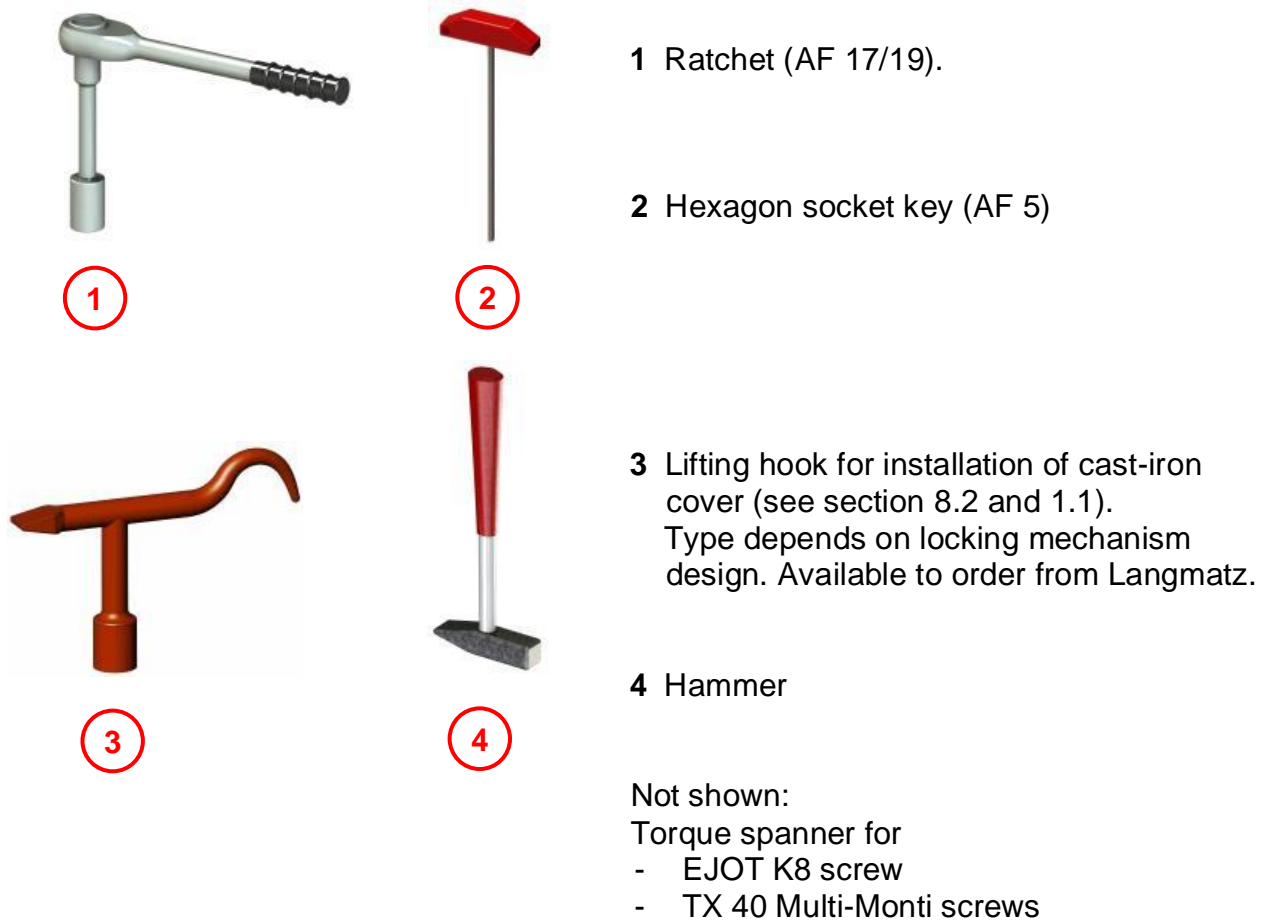

Fig. 3

4.2 Tightening torque table

Maximum permissible tightening torques for metric threads.

Thread	Strength class	Tightening torque Nm
M4	6.8	2.23
M5	6.8	4.52
M6	6.8	7.69
M7	6.8	10.27
M8	6.8	18.70
M10	6.8	37
M12	6.8	65

Fig. 4

5 Foundation pit base

5.1 General

The foundation must be installed by a specialist company.

Assess the ground conditions before preparing a load-bearing foundation pit base.

- For polycarbonate foundations with an overall height of less than 680 mm, the highest groundwater level must be at least 1,200 mm below ground level.
- The foundation must be installed in “non-cohesive” to “cohesive” mixed soils.
- Group G1 to G3 soil types as per ATV-DVWK-A (German Association for Water, Wastewater and Waste) 127, and/or soil groups GE, GW, GI, SE, SW, SI, GU, GT, SU, ST, GU*, GT*, SU*, ST*, UL and UM as per DIN 18196.

5.2 Preparing the foundation pit base

When preparing the foundation pit, comply with the following documentation from the Gütegemeinschaft Leitungstiefbau e.V. (Underground Cable Line Construction Quality Association):

“Procedural instructions for working in underground cable line construction”.

The position and depth of the foundation pit base must match the installation situation. The upper edge of the polycarbonate foundation (upper edge of the steel frame) must lie completely flush with the surrounding terrain without shoulder.



Warning:

- Do not install the polycarbonate foundation in road carriageways!
- When installing in vehicle traffic areas, such as car parks, provide a cast-iron cover in accordance with B125 (see section 11 Accessories).
- When installing a charging column, provide protective elements, such as protective bars/bollards/kerbs.

5.3 Installation situations

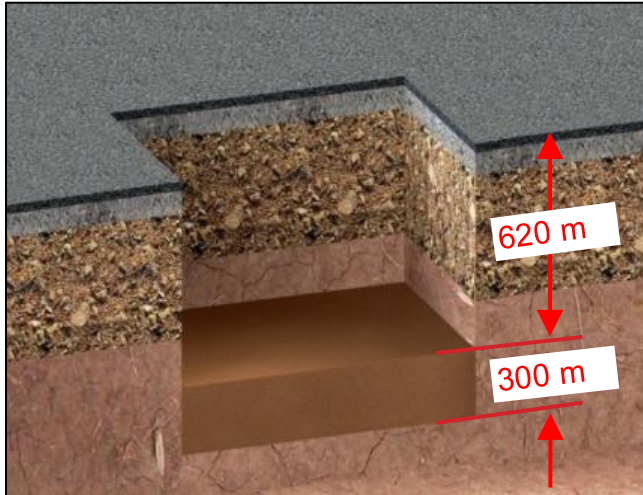

Fig. 5

Situation A

For pedestrian areas:

- Use an underfill/bottom layer of at least 300 mm thick.
- The underfill/bottom layer must consist of “non-cohesive” to “cohesive” mixed soil (group G1 soil type as per ATV-DVWK-A127).
- The underfill/bottom layer must be layered and compacted to $D_{Pr} \geq 98\%$.

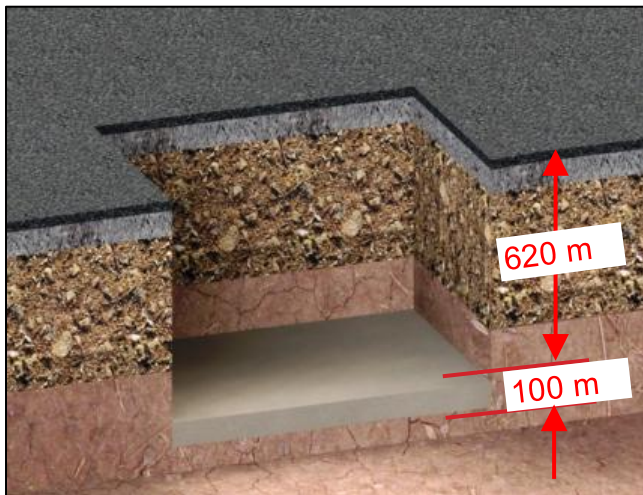

Fig. 6

Situation B

For vehicle traffic areas:

- Compact the pit base according to the requirements.
- With group G1/G2 soil types as per ATV-DVWK-A 127 (soil groups GE, GW, GI, SE, SW, SI, GU, GT, SU, ST as per DIN 18196).
- Lay a concrete load-bearing layer of at least 100 mm thick (tamped concrete, strength class $\geq C8/10$).

6 Installation – Polycarbonate foundation with base plate/adapter plate

6.1 Constructing the base

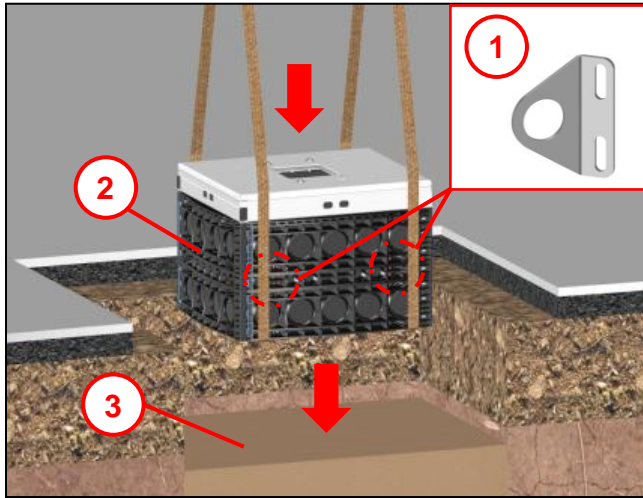

Fig. 7

- Place the polycarbonate foundation (2) on the foundation pit base (3).



Warning!

- Use slings when inserting the foundation!
- Optionally with previously fitted transport hooks (1) (see section 11 Accessories).
- Fit the transport hooks to the existing domes using the enclosed screws.
- Risk of injury due to the polycarbonate foundation tipping and falling!

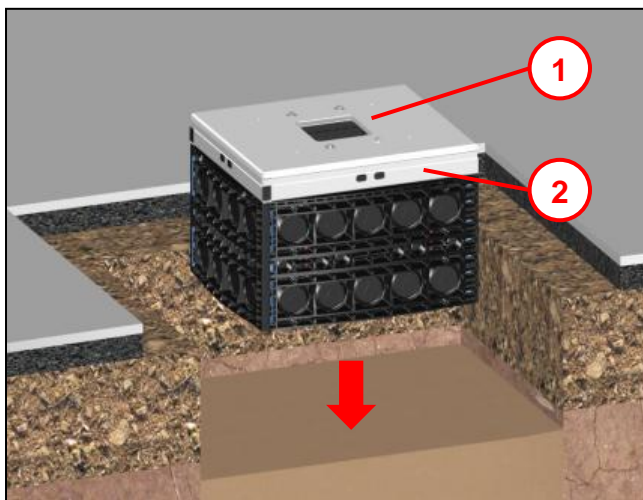

Fig. 8



Warning!

- Never use the openings or lugs on the base plate (1) to lift the polycarbonate foundation!
- The screw connections could be ripped out, damaging the steel frame (2).

6.2 Dismantling the base plate and adapter plate

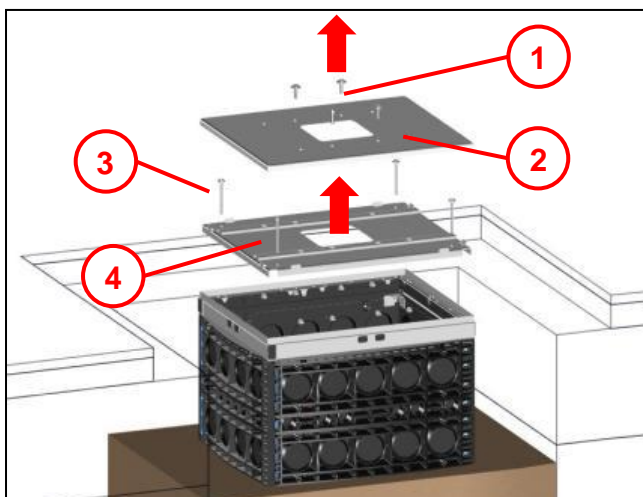

Fig. 9

- Undo the hex screws (1) and remove the base plate (2).
- Undo the 4x M10x160 hex screws (3) and remove the adapter plate (4).

6.3 Removing the predetermined breaking points for cable ducts

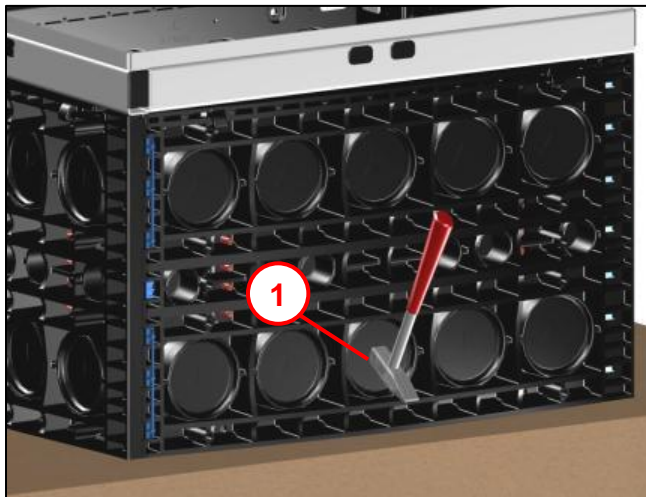

Fig. 10

- Establish the required number and position of the cable ducts.
- Knock out the relevant predetermined breaking points **(1)** with a hammer.
- Remove any burrs with a suitable tool.

Note: When using more than one polycarbonate foundation in a row, also knock out the predetermined breaking points on the opposite side so that conduits can be routed through all polycarbonate foundations. This allows subsequent cabling without opening the base plate/adaptor plate.

6.4 Fitting the stepped grommet

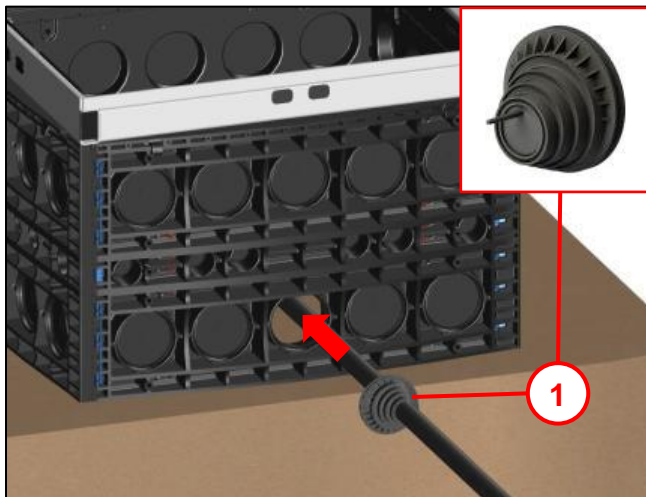

Fig. 11

To prevent the polycarbonate foundation from silting up, we recommend using a stepped grommet **(1)** when laying pipes. (2x enclosed).

- Using a suitable tool, open up the required pipe diameter at the predetermined breaking point on the stepped grommet.
- Insert the stepped grommet into the opening as shown.

6.5 Optional: Installing a strain relief rail

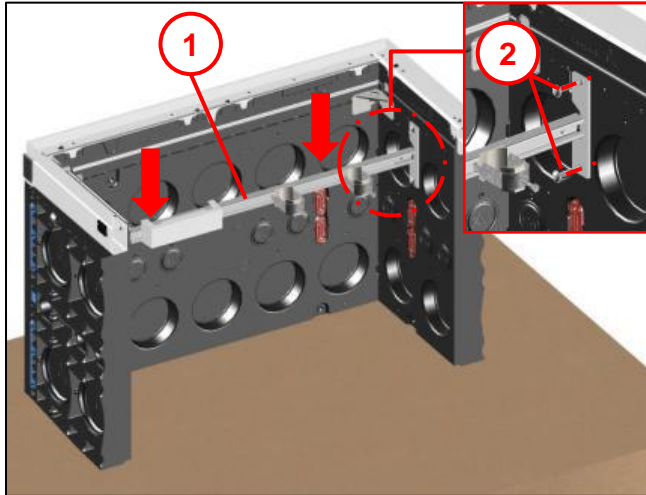

Fig. 12

A strain relief rail (1) can optionally be fitted (not included in delivery. See section 11 Accessories).

- Insert the strain relief rail (1) and fit it to the polycarbonate foundation outside the predetermined breaking points.
- Pre-drill the screw points with a $\varnothing 6$ mm drill.
- Screw the strain relief rail (1) tight with 4x EJOT PT K8x22 screws (2).

6.6 Backfilling the foundation pit

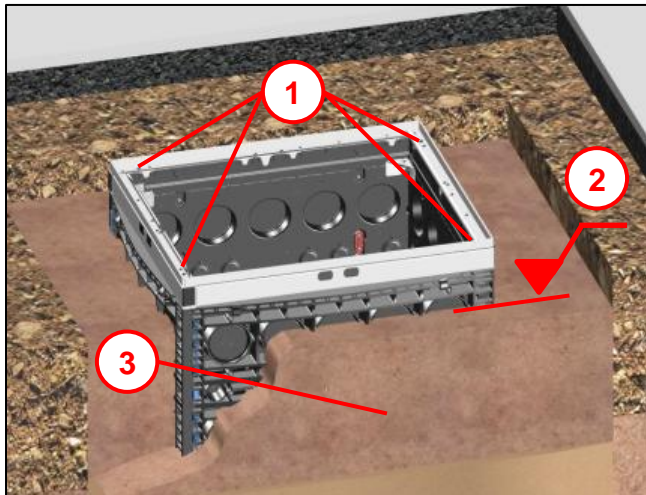

Fig. 13

- Backfill and compact the foundation pit in layers using material suitable for compacting (3) in accordance with ZTV E-StB 09 up to the lower edge of the top layer (2).

Note!

- Protect the 4x openings for height adjustment/threaded spindles (1),
- and all other openings in the steel frame, against contamination when backfilling!

6.7 Height adjustment

6.7.1 Adjusting the height at the steel frame

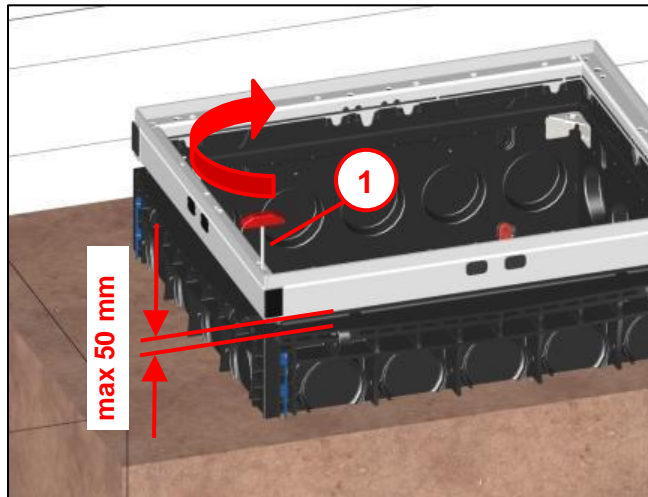

Fig. 14

- Turn the AF5 hexagon socket key **(1)** clockwise at all four height adjustment points to lift the steel frame and adjust it to the intended height.

Note:

The ideal adjustment range is at least 20 mm to maximum 50 mm.

6.7.2 Filling the foundation pit and free space

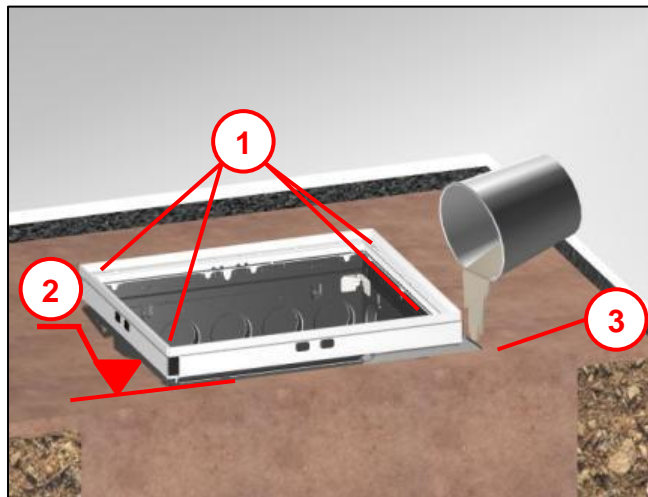

Fig. 15

- Backfill and compact the foundation pit up to the upper edge of the polycarbonate frame **(2)**.
- Backfill the resulting free space between the steel frame and polycarbonate frame **(3)**.
 - Backfill according to DIN 18555.
 - Compressive strength $>35 \text{ N/mm}^2$ after 28 days.
- Construct the top layer up to the steel frame as required (concrete, paving, etc.).

Note:

- Protect the 4x openings for height adjustment/threaded spindles **(1)**,
- and all other openings in the steel frame, against contamination when backfilling!

6.8 Installing the base plate and adapter plate

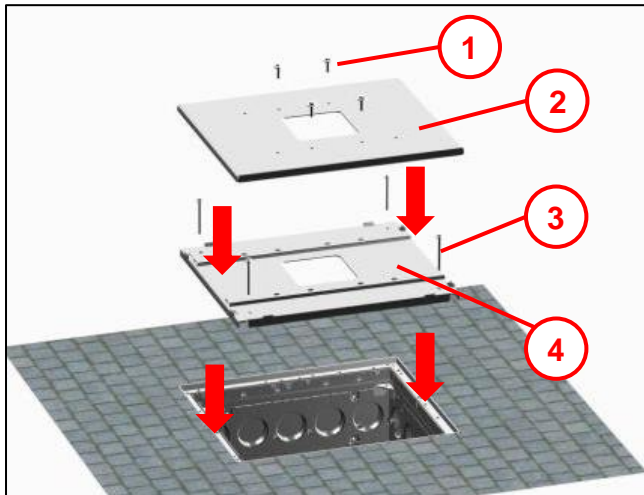

Fig. 16

- Place the adapter plate **(4)** on the steel frame **(without** damping pad).

Note: Apply anti-seize paste to all hex screws before screwing them in!

- Fasten the adapter plate **(4)** with
 - 4x M10x160 hex screws **(3)** and
 - 4x washers.
- Place the base plate **(2)** on the adapter plate **(4)**.
- Fasten with
 - hex screws **(1)** and
 - washers.
- Pay attention to the maximum torque (see table in section 4.2)!

Optional:

- Polycarbonate foundation with cast-iron cover, for later erection of a charging column (see section 8).
- Retrofitting on the polycarbonate foundation for cast-iron cover (see section 9).

7 Installing the charging column (not included in delivery)

7.1 Opening the screw connection

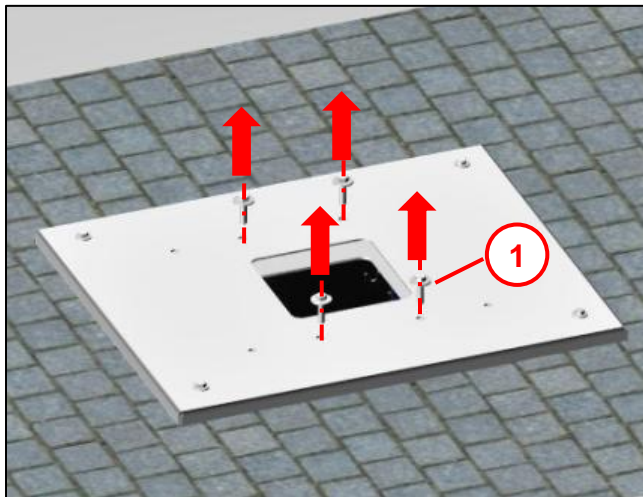

- Remove the hex screws **(1)** and washers.

Fig. 17

7.2 Earthing requirement

The earthing concept must address local requirements and the type of charging column. Generally, the charging column and foundation must be earthed by a qualified electrician. The operator / installer is responsible for ensuring that effective earthing and lightning protection measures are put in place in accordance with standard-compliant and legal regulations when setting up the foundation and charging column.

7.3 Example of earthing with a rebate clamp (not supplied)

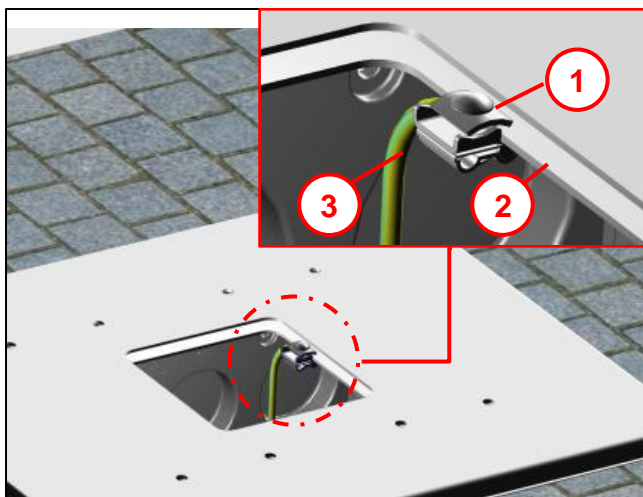

- Properly fit the earthing rebate clamp **(1)** to the adapter plate **(2)**. (e.g. such as supplied by DEHN type 365250)
- Then attach the earthing cable **(3)** to the rebate clamp.

Fig. 18

7.4 Installing the charging column

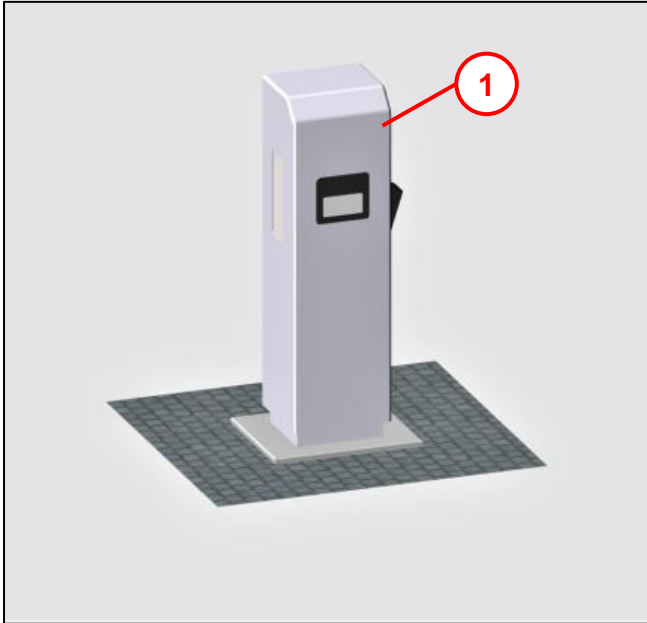

Fig. 19

- Install the charging column **(1)** (not included with delivery) with the hex screws previously removed (see section 7.1).
Observe the maximum torque (see table in section 4.2)!

8 Optional installation – Polycarbonate foundation with cast-iron cover

- for later installation of a charging column -

8.1 Installation of the polycarbonate foundation

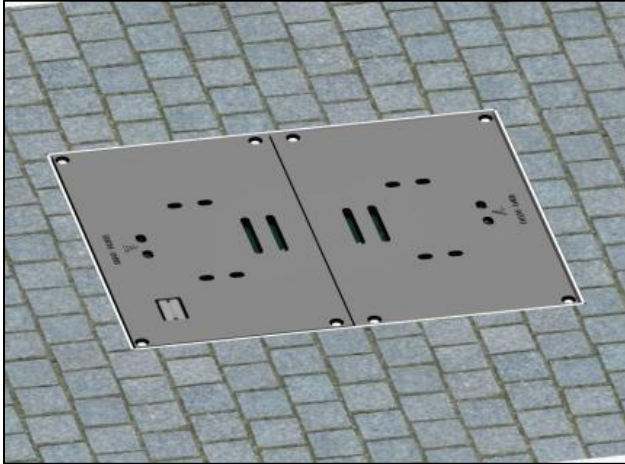

Fig. 20

- Installation of the polycarbonate foundation as described in section 5 and 6.

8.2 For installation of the charging column – Dismantling the cast-iron cover

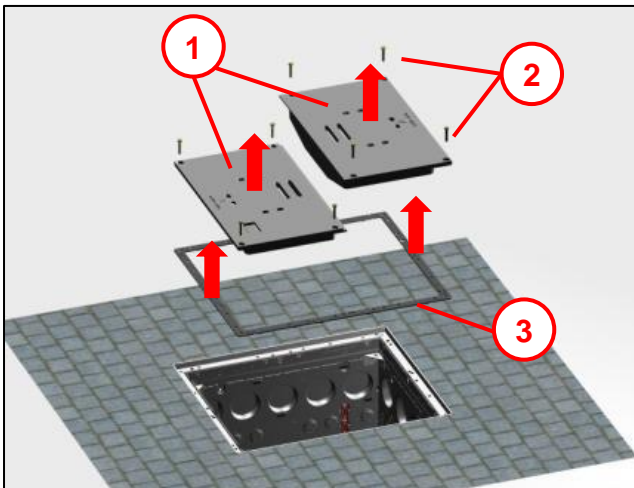

Fig. 21

- Undo 8x M10 hex screws **(2)** and remove the cast-iron cover **(1)** using a suitable lifting tool.
- Remove the damping pad **(3)**.

Note:

The damping pad **(3)** may **not** be used when installing the base plate, adapter plate and charging column!

8.3 Set – Installing the base plate/adapter plate

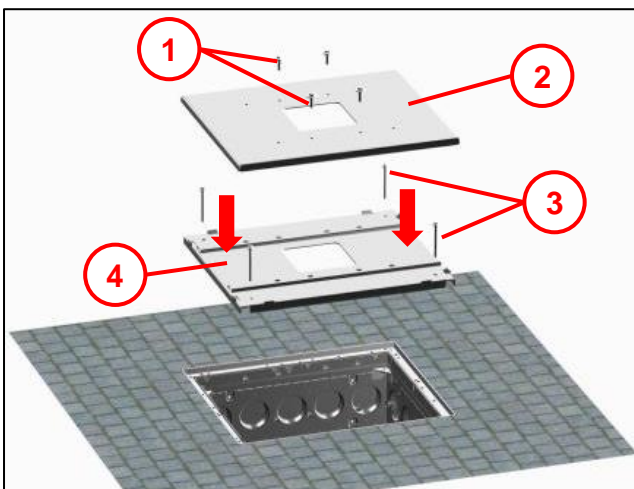

Fig. 22

- Place the adapter plate **(4)** on the steel frame (**without** damping pad).
- Fasten with
 - 4x M10x160 hex screws **(3)** and
 - 4x washers.
- Place the base plate **(2)** on the adapter plate **(4)**.
- Fasten with
 - hex screws **(1)** and
 - washers.
- Observe the maximum torque (see table in section 4.2)!
- Install the charging column (see section 7.4).

9 Optional installation – Cast-iron cover as a retrofit kit

9.1 Installation of fixings

9.1.1 Screw locks 1

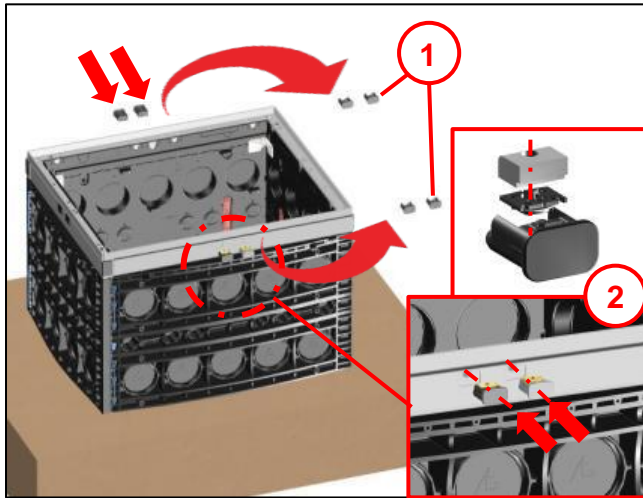

Fig. 23

Note:

- The fixings are installed before insertion into the foundation pit!
- If the polycarbonate foundation is installed, expose the steel frame!
- Dismantle the base plate and adapter plate (see section 6.2).
- Remove 4x hole plugs **(1)** on the long side of the steel frame.
- Insert 4x receptacles with screw locks for M10 hex screws **(2)** (from the retrofit kit) into the openings.

9.1.2 Screw locks 2

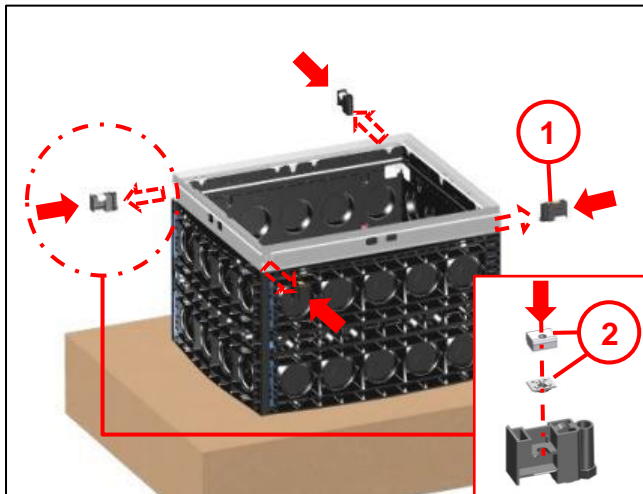

Fig. 24

- Remove 4x fitted end caps **(1)** from the steel frame and dispose of them.
- Use 4x new end caps (from the retrofit kit).
- Insert 4x screw locks **(2)** into the recesses provided in the end caps.
- Refit all end caps completely in the steel frame.

9.2 Installation of the cast-iron cover

9.2.1 Inserting the damping pad

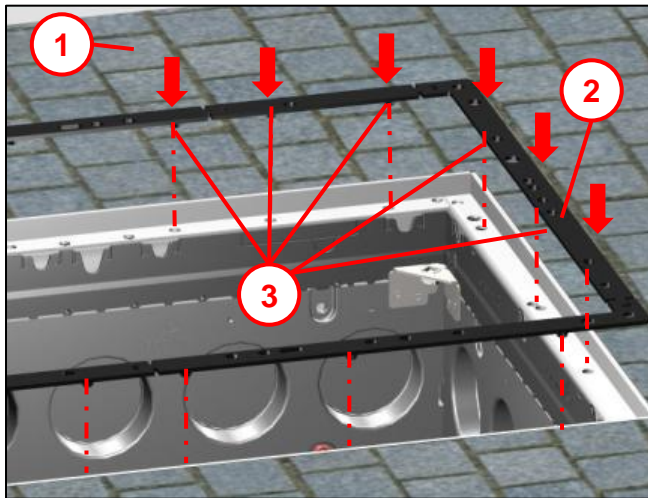

Fig. 25

- Insert the polycarbonate foundation into the foundation pit and backfill (see section 6.6).
- Construct the top layer **(1)** up to the steel frame as required (concrete, paving, etc.).
- Press the damping pad **(2)** (from the retrofit kit) with 16x moulded pins **(3)** into the holes provided.

9.2.2 Inserting the cast-iron cover

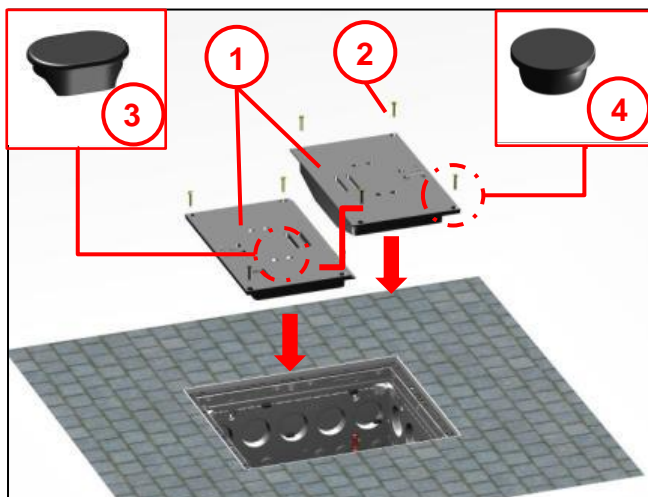

Fig. 26







- Insert 2x cast-iron covers **(1)** using a suitable tool (observe overlap/underlap)!
- Fasten the cast-iron cover with 8x M10 hex screws **(2)**.
- Cover the hex screws with 8x sealing plugs **(4)**.
- Close the levering holes with 12x hole plugs **(3)**.

10 Maintenance

Base plate screw connection		
Treat the locking screws with anti-seize paste before screwing them into the base plate.		Only screw in the locking plugs by hand before final tightening! Anti-seize paste is available from Langmatz (see section 15 Contact).
Only tighten with a suitable tool (see section 4.1). For the recommended tightening torque, see the table in section 4.2.	After each use.	

Maintenance requirements
No specific requirements.

11 Accessories

Article	Article number	
Strain relief rail with earthing option (potential equalisation rail with two BK42 clamps).	700887630	
Stepped grommet Ø110 mm	062680008	
Base plate Dimensions: 900 x 785 mm Material: S235 JR	Depending on the design	
Adapter plate Dimensions: 885 x 735 mm Material S235 JR	Depending on the design	
Cast-iron cover as per DIN EN 124 D400 for CD 650 x 800 Note! D400 is only fulfilled if completely screwed down	700887620	
Transport hook set	700887611	

12 Material defects

Langmatz accepts liability for material defects in the product as per Section 434 BGB (German Civil Code) for 24 months, starting from the date on the purchase receipt.

Within the scope of liability, all parts that become damaged due to manufacturing faults or material defects will be replaced or repaired free of charge.

The purchaser must report any deficiency complaints immediately in writing.

Claims by the purchaser for damages due to material defects or for whatever legal reason will not be accepted.

Any damage or failure caused by the following are also excluded from liability:

- incorrect use,
- natural wear and tear
- intervention by third parties.

We accept no liability for damage caused by force majeure or transport.

Repairs due to a complaint about a defect do not extend the warranty period for the replaced parts or for the product.

13 Quality management

The Langmatz GmbH quality management system is certified to DIN EN ISO 9001.

14 Disclaimer/Warranty

The information in this technical document is presented appropriately and correctly in compliance with the technical regulations, and to the best of our knowledge. However, this does not confer any guarantee of particular characteristics. In this context, the company that operates the products supplied by Langmatz GmbH is expressly obliged to decide, based on its own judgement, whether the products are suitable and appropriate for the application or use being considered. The product liability accepted by Langmatz GmbH relates exclusively to our conditions of sale, delivery, and payment. Langmatz GmbH accepts no liability on the basis of random, indirect and resultant consequential damage, or of any damage attributable to any use of the product other than its intended purpose as described.

15 Contact

Langmatz GmbH
Am Gschwend 10
82467 Garmisch-Partenkirchen, Germany

Our hotline: +49 88 21 920 – 137
Phone: +49 88 21 920 – 0
Email: info@langmatz.de
www.langmatz.de

