

Installation Instructions

Fibre distribution cabinet

FDC-L 3.0 in cabinet KVz22

prepared for the Langmatz fibre tray system



Contents

1	General information.....	4
2	Safety information	4
3	Product description	5
3.1	Dimensions.....	5
3.2	Technical data	6
4	Package includes	7
5	Base plate design.....	8
6	Installing the cabinet on the pedestal	9
7	Installing the pipe bundles / micro cables.....	10
7.1	Preparing the pipe bundles / micro cables	10
7.2	Attaching the micro-duct pipes in the pedestal	11
7.3	Micro-duct pipe set-up / function in the cabinet	11
7.4	Inserting the micro-duct pipes in the cabinet	12
7.5	Micro-duct pipe strain relief	13
8	Installation of the optical fibre main cable in the inlet area	14
8.1	Inserting the main cable / bundled loose tube fibres	14
8.2	Loop	16
8.3	Conversion option for micro cable organiser and cable organiser access.....	16
8.4	Ongoing routing of main cable / mini cables / bundled loose tube fibres.....	18
9	Micro cable assembly in the outlet area	19
10	Inserting the micro cables (at fibre tray level)	20
11	Use of the protective cover	21
12	Description of the Langmatz fibre tray system	22
12.1	Mounting panel.....	22
12.2	Description of the splice fibre tray	23
12.3	Inserting the fibre tray.....	23
12.4	Removing the fibre tray	24
13	Inserting and splicing optical fibres	24
13.1	Inlet fibres to the fibre tray	24
13.2	Splicing fibres	25
13.3	Change in direction of the fibres in the fibre tray	26
13.4	Side optical fibre cable guide.....	26
13.5	Fibre bridge	27

13.6	Fibre tray cover	27
14	Cabinet replacement.....	28
14.1	Removing the earthing	28
14.2	Removing the rear panel	28
14.3	Removing the brackets.....	29
14.4	Removing the cable routing.....	29
14.5	Loosening the mounting panel	30
14.6	Releasing the door	31
15	Double swivel lever.....	32
16	Earthing	33
16.1	Earthing kit	33
16.2	Preparation.....	33
16.3	Pre-assembly of the earthing flag.....	34
16.3.1	Installation of the earthing cable (1x)	34
16.3.2	Installation of the cable holder for Ø6 mm - Ø10 mm.....	34
16.4	Installing the earthing flag in the KVz22	35
17	Order data and accessories.....	Fehler! Textmarke nicht definiert.
18	Material defects.....	36
19	Recycling	36
20	Cleaning, repainting.....	36
21	Quality management.....	36
22	Disclaimer/Warranty.....	36
23	Contact	37

1 General information

These installation instructions describe use of the differently configured “fibre distribution cabinet” in the KVz22 outdoor cabinet and form part of the delivery.



Note:

Any person involved in the assembly, operation, maintenance and repair of the product must first have read, understood and followed these instructions. We accept no liability for damage and operating malfunctions caused by failure to comply with these instructions.

In the interest of further development, we reserve the right to change individual assemblies and accessories as considered necessary for enhanced safety and performance improvements, while preserving the main features.

The product described here corresponds to the latest state-of-the-art technology at the time of printing and is delivered in an operationally safe condition.

The copyright of these instructions remains with Langmatz GmbH.

2 Safety information



- **Note the possibility of laser/LED radiation in the non-visible spectrum!**
- Never look into open fibre ends if there is an unknown level of risk posed by laser/LED radiation.



Note!

The level of risk should ultimately be decided by the system fitter/operator of the communication system, who is responsible for labelling the system accordingly (e.g. attaching warning signs in accordance with DIN EN/IEC 60825-1, as revised, and in compliance with the BGV (Employers' Liability Association) B2 “Laser radiation”, as revised).

If the technical data changes, and this affects the level of risk, the warnings must be adjusted accordingly and work safety measures taken, see also DIN EN/IEC 60825-2, as revised.



Note!

The relevant safety regulations must be observed during all assembly, operation and repair work.

The operating company is responsible for installing, operating and maintaining the fixtures.

Unauthorised modifications, particularly to safety-related parts, are prohibited. Langmatz GmbH warns against the misuse of the product.

The operator is responsible for the following:

- Preventing danger to life and limb of users and third parties,
- Ensuring safe operation of the system,
- Precluding downtime and environmental impact due to incorrect handling,
- Ensuring that protective clothing is worn when working with or on the product.

Do not use the product if it is damaged. Please contact the hotline (see reverse).

3 Product description

The FDC consists of the following main product components:

- Cabinet KVz22
- Pedestal 2.0
- FDC installation kit
- FTTH base plate
- Mounting panel for the fibre tray system

The proper installation and configuration of the fibre distribution cabinet is described in detail in these installation instructions.

3.1 Dimensions

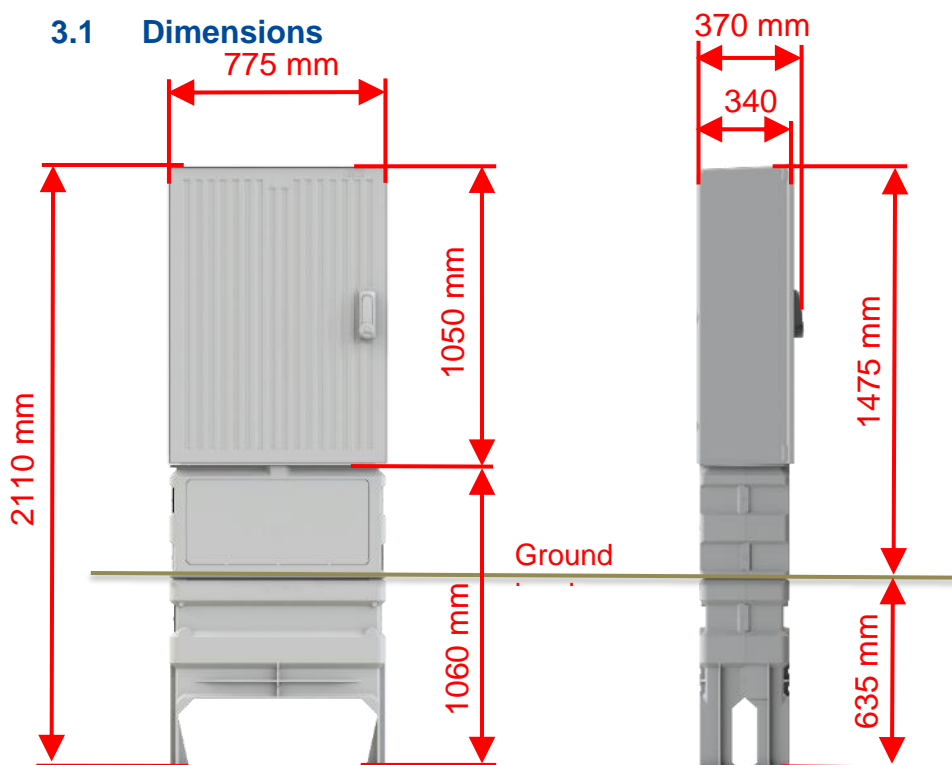

Fig. 1

Fig. 2

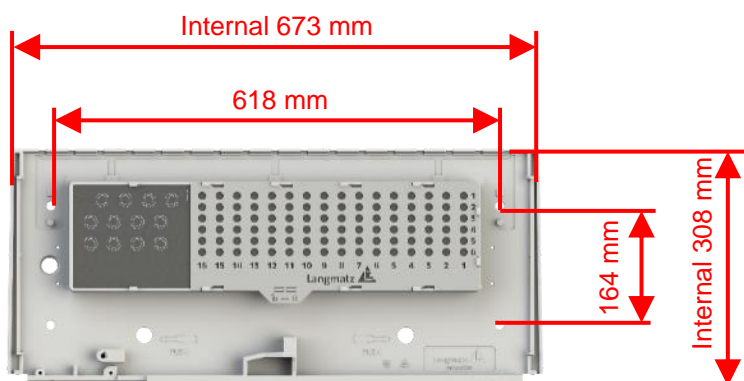

Fig. 3 Example of base plate

3.2 Technical data

Forced-entry protection safety level according to DIN 47609: T3

W x H x D:	775 x 2110 x 340 mm
Cabinet:	54 kg
Pedestal:	19 kg
Total weight:	73 kg
Weight of one cabinet (cabinet and pedestal) including packaging and pallet:	96 kg
Weight of two cabinets (cabinet and pedestal) including packaging and pallet:	169 kg
Cabinet material:	polycarbonate
Degree of protection:	IP54
Resistance:	<ul style="list-style-type: none">• UV-resistant, weather-resistant and self-extinguishing• environmentally-friendly plastic and recyclable
Colour:	cabinet body coated in RAL 7038 with environmentally-friendly paint
Version:	<ul style="list-style-type: none">• ribbed surface (difficult to adhere posters to the surface)• 7-locking mechanism door with turning lever, prepared for one or two profile half-cylinders

4 Package includes

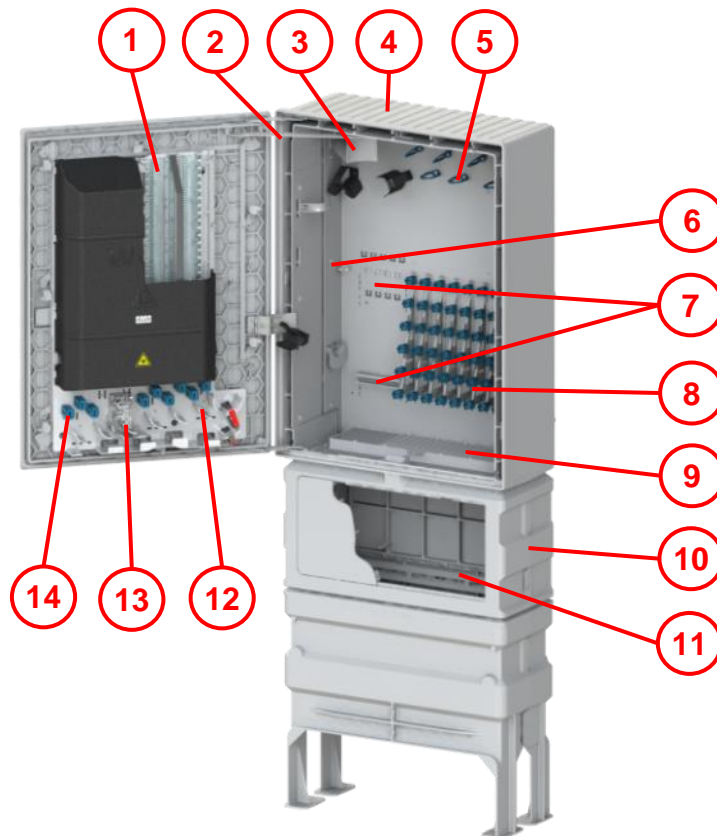

Fig. 4

Pos. 1 Fibre tray system level

Pos. 2 Door stay

Pos. 3 Cable diverter

Pos. 4 Cabinet KVz22

Pos. 5 Guide rings

Pos. 6 Excess cable tray

Pos. 7 Main cable strain relief, micro-duct pipes and core of fibre cable
Not shown: Optional mounting and strain relief in the inlet area for second and third row

Pos. 8 Mount for micro-duct pipes

Pos. 9 Base plate with sealing plate and strain relief (strain relief only for outlet area)

Pos. 10 Pedestal (not screwed to the cabinet when delivered)

Pos. 11 Strain relief rail

Pos. 12 Bending radius limiter

Pos. 13 Cable organiser access

Pos. 14 Micro-duct cable organiser

Not shown:

- Mandrels $\varnothing 7/10/12$
- Spiral tube 0.4m
- 14x cable ties 140 mm
- 3x bundle hook-and-loop straps
- 2x cover for uppermost fibre trays

Depending on the design

- 60x strain-relief lugs $\varnothing 12$ or
- 96x strain-relief lug duo $\varnothing 7/10$
- 120x strain-relief lug duo $\varnothing 7/10$
- Set of screws for fixing to the pedestal
- Fibre trays
- Adapter set for entry area second and third level
- U-clamps

5 Base plate design



Fig. 5

(1) Sealing plate

(2) Strain relief plate

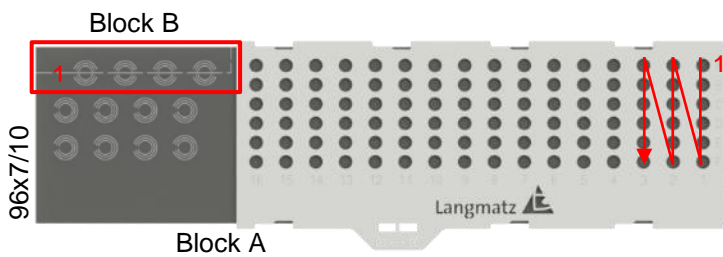

Fig. 6

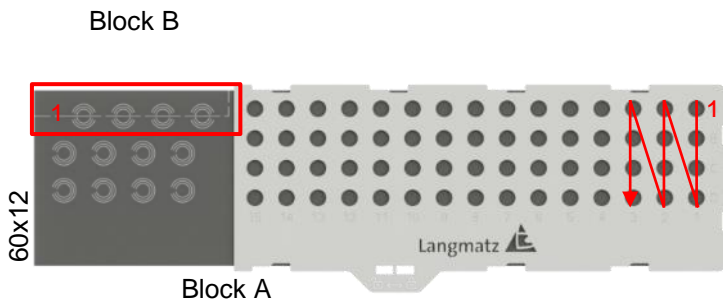

Fig. 7

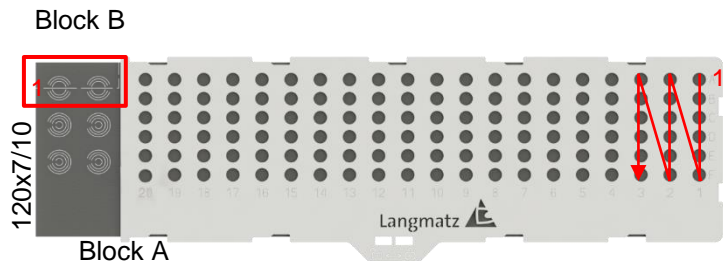

Fig. 8

Block A	Block B
96x 7/10 (Micro-duct pipe $\varnothing 7$ or $\varnothing 10$ mm)	4x 12-20 (Micro- duct pipe $\varnothing 12$, $\varnothing 16$, $\varnothing 20$ / main cable / divisible cable entry element for loop)
8x 12-20 (Micro-duct pipe $\varnothing 12$, $\varnothing 16$, $\varnothing 20$ / main cable)	
60x 12 (Micro-duct pipe $\varnothing 12$ mm)	2 x 12-20 (Micro-duct pipe $\varnothing 12$, $\varnothing 16$, $\varnothing 20$ / main cable / divisible cable entry element for loop)
8x 12-20 (Micro-duct pipe $\varnothing 12$, $\varnothing 16$, $\varnothing 20$ / main cable)	
120x 7/10 (Micro-duct pipe $\varnothing 7$ or $\varnothing 10$)	4x 12-20 (Micro-duct pipe $\varnothing 12$, $\varnothing 16$, $\varnothing 20$ / main cable)
4x 12-20 (Micro-duct pipe $\varnothing 12$, $\varnothing 16$, $\varnothing 20$ / main cable)	

The divisible sealing plate for cable entry in Block B:

- Entry point of the main cable or micro-duct pipe
- Provides for a loop (uncut cable)

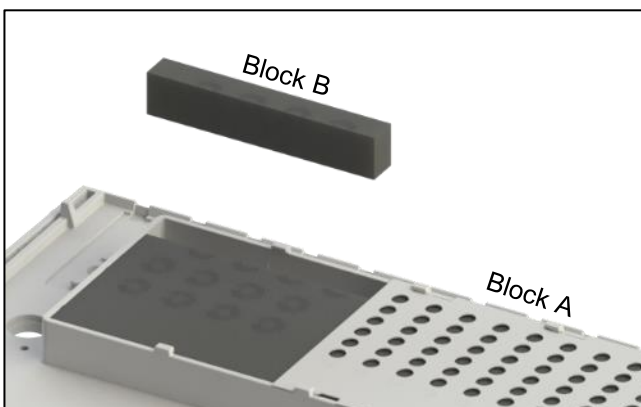

Fig. 9

6 Installing the cabinet on the pedestal

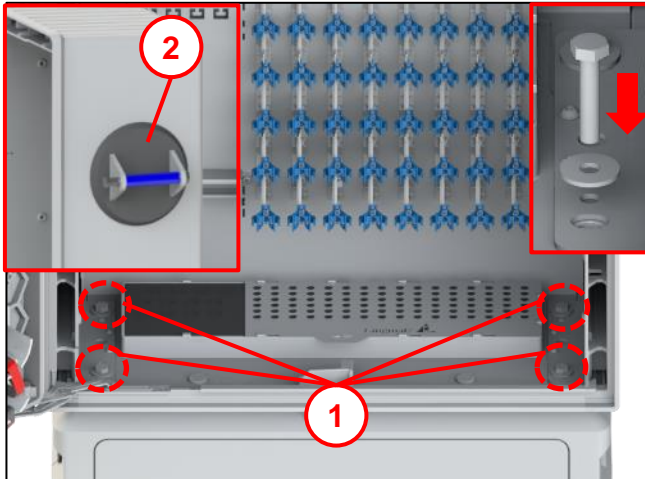

Fig. 10

Two people are needed to install the cabinet.

- Position the cabinet on the pedestal and screw together with 4x hex screws M10x50 and 4x washers 10.5 (1).

Note: An appropriate suction lifter (2) can be used to lift the cabinet.

7 Installing the pipe bundles / micro cables

7.1 Preparing the pipe bundles / micro cables



Note: Use the specified tools to handle pipe bundles / micro cables.

For pipe bundles (1)

For micro cables (2)

Fig. 11

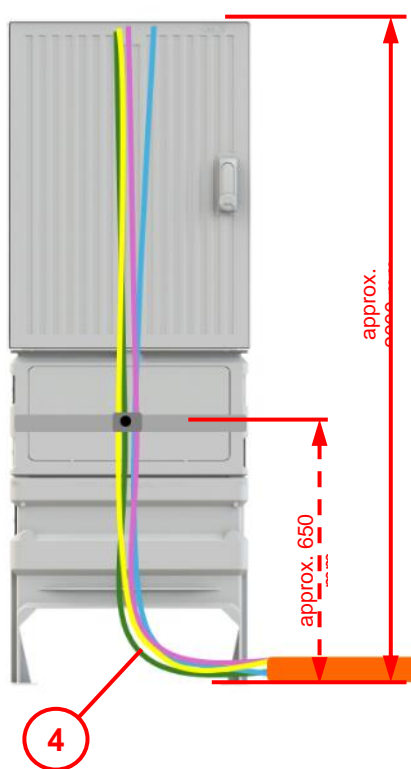

The length of the micro-duct pipes is approx. 2 m from the pedestal inlet

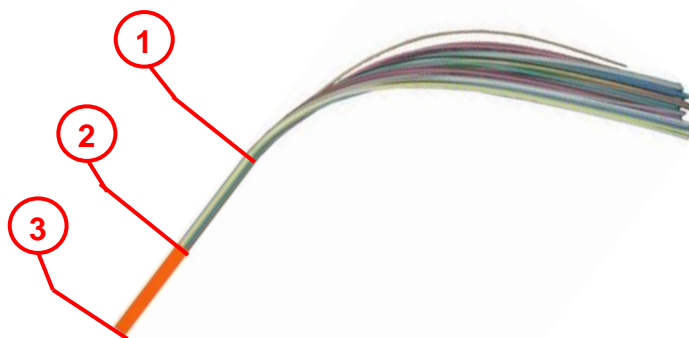

Pos. 1 Upper edge of U-clamp – pedestal

Pos. 2 Remove the sheath

Pos. 3 Pedestal inlet

Pos. 4 Note the laying instruction with regard to the bending radii and when laying the pipe bundles and micro-duct pipes

Fig. 12

Note: The design, colour coding and the number of micro-duct pipes can deviate from the illustration shown depending on the manufacturing version of the pipe bundle.

7.2 Attaching the micro-duct pipes in the pedestal

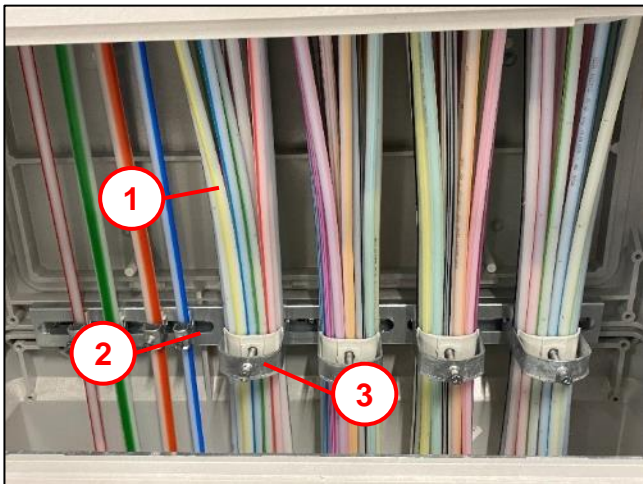

Fig. 13

- Attach the micro-duct pipes (1) on C-DIN rails (2) with U-clamps (3) (scope of delivery varies according to the version).

7.3 Micro-duct pipe set-up / function in the cabinet

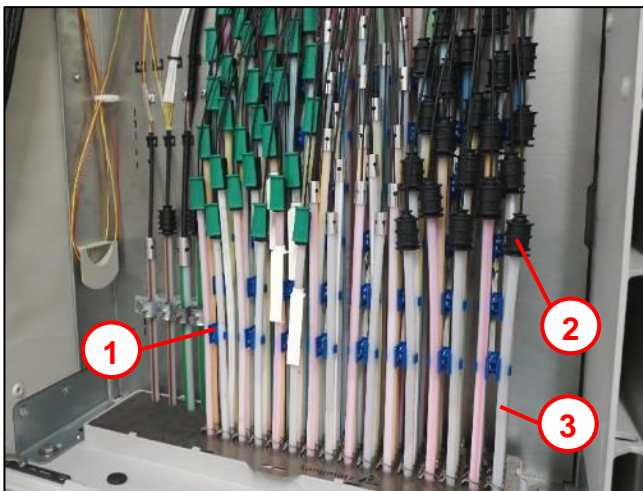

Fig. 14

The micro-duct pipes are installed according to the installation matrix from rear right to front left.

They are organised by clamp mounts with duo clamps (1) fitted on the rear panel.

Note: For reasons of space, the micro-duct pipes (3) ($\varnothing 10 / \varnothing 12$) and micro-duct gas stops (2) must be graduated, see Fig. 16.

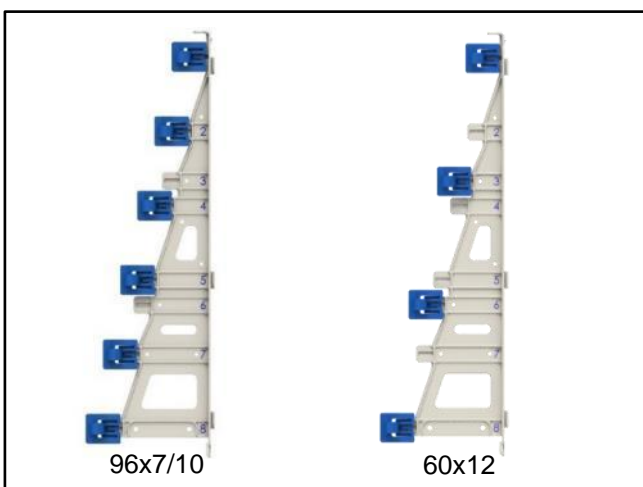

Fig. 15

The micro-duct pipes $\varnothing 7/10$ and $\varnothing 12$ mm are organised and held in place using duo clamps.

7.4 Inserting the micro-duct pipes in the cabinet

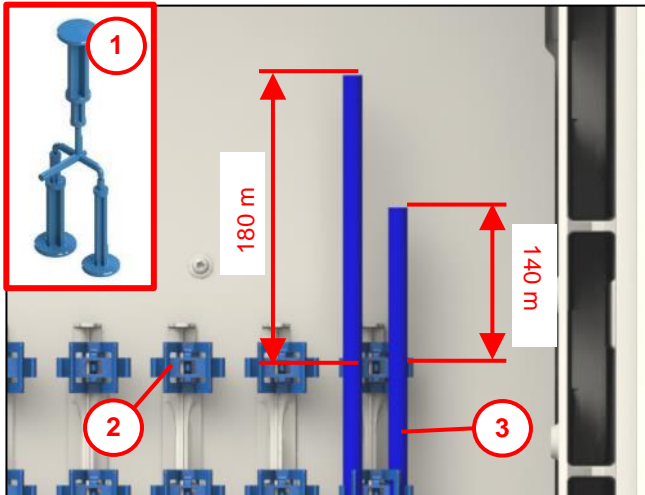

Fig. 16

- Insert the micro-duct pipes (3) into the cabinet.

Note:

Insert the micro-duct pipes through the base plate in the outlet area using the mandrel (1) ($\varnothing 7/10/12$ depending on the design) (note the installation information contained in “Mandrel and insertion aid for micro-duct pipes”).

There needs to be an alternate additional length of 140 mm or 180 mm above the duo clamp (2) in order to attach sealing and labelling elements and labels.

7.5 Micro-duct pipe strain relief

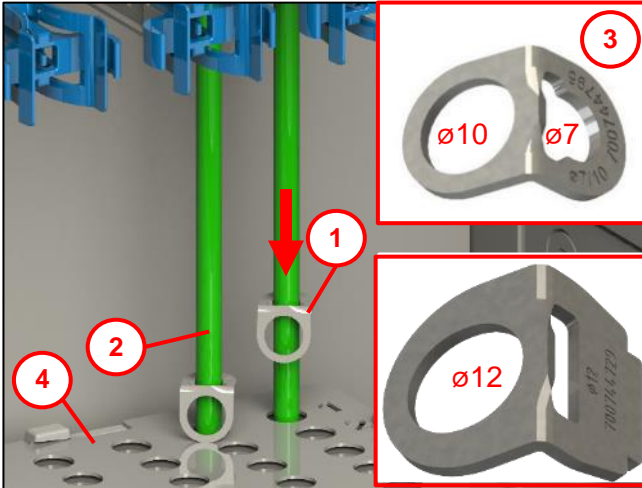

Fig. 17

- Place the strain-relief lug (1) on the micro-duct pipe (2) with the lug pointing down.
Note: Use the designated side of the strain-relief lug depending on the diameter of the micro-duct pipe with the duo strain-relief lug (3) for $\varnothing 7/10$ mm micro-duct pipes (one lug for two sizes).
- Push the strain-relief lug (1) over the micro-duct pipe (2) as far as the strain relief plate end stop (4).
 The strain relief plate also fixes the micro-duct pipes in place and provides strain relief.

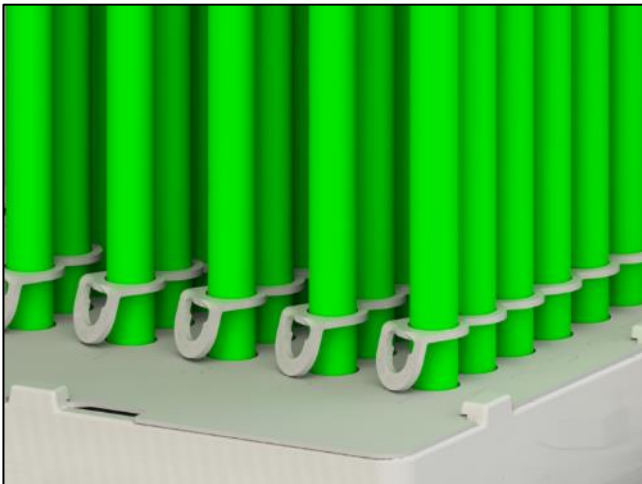

Fig. 18

Note: Arrange the strain-relief lugs to point in the same direction!

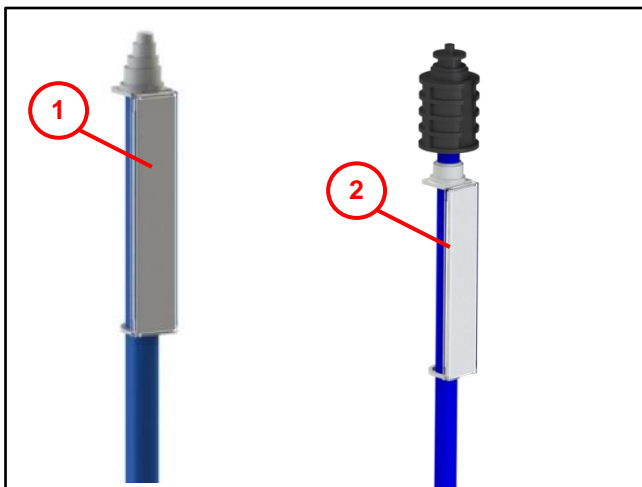

Fig. 19

If labelling plates are to be fitted, they must be installed prior to installation of the micro-duct gas stops.

- (1) Closed, used as a labelling plate and cap
- (2) Open, used as a labelling plate

Pay attention to the installation instructions for the labelling plates!

8 Installation of the optical fibre main cable in the inlet area

8.1 Inserting the main cable / bundled loose tube fibres

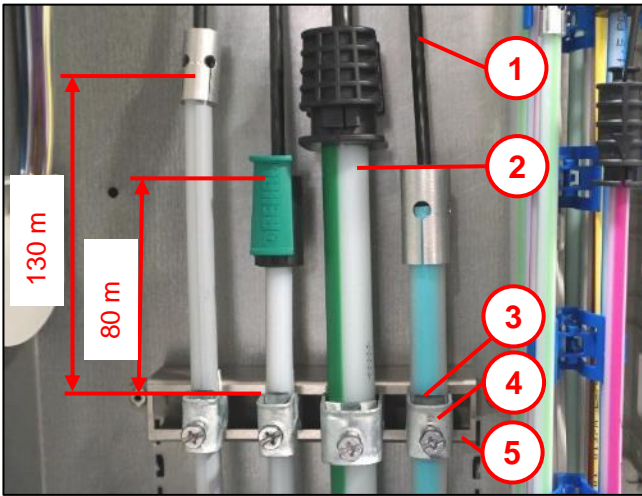

Fig. 20

- Insert the micro-duct pipes (2) for the optical fibre mini cable (1) into the cabinet through the base plate (inserting micro cables, see section 7.4).
- Fix the micro-duct pipe with U-clamp (5) and counter-trough, double trough (4) onto the C-DIN rail (5).
Note: Only tighten the fastening screw **hand-tight**.
- Alternately, strip the micro-duct pipe 80 mm or 130 mm above the C-DIN rail.
- Insert the optical fibre mini cables (provide micro-duct gas stops according to the manufacturer's installation instructions) or air cables.

Note: The following options are available to route the cables or bundled loose tube fibres for the four mounting points (standard) on the rear panel:
(8 further mounting points are possible using the adapter set accessory)

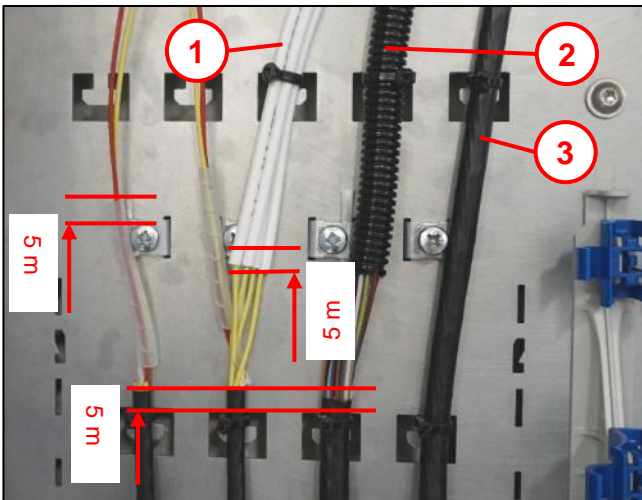

Fig. 21

- Cables (3) on the door
max. 4 pcs. for max. $\varnothing 10$,
max. 7 pcs. for $\varnothing 6.5$.
- Bundled loose tube fibres in a corrugated tube 2
max. 4 pcs. on the door for max. $\varnothing 13.5$.
- Bundled loose tube fibres in protective tubes
 $6 \times \varnothing 4$ (1) on the door.

Note: Store bundled loose tube fibres that are not currently required on the excess cable tray.

Regarding mounting on the cable organiser access on the door see Fig. 30.

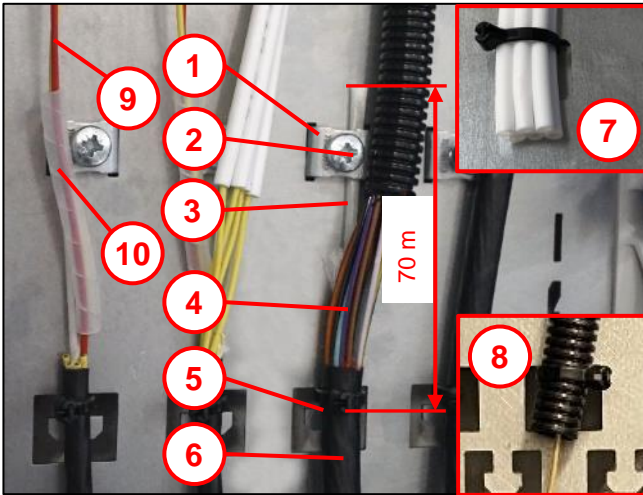

Fig. 22

- Strip the core of fibre cable **(3)** to 70 mm and guide under the clamping yoke **(1)**.
Note: Alternative strain relief on the door side, see Fig. 30.
- Protect the bundled loose tube fibres **(9)** in the area of the clamping yokes with a spiral tube **(10)**.
- Strip the bundled loose tube fibres **(4)** as per the specification.
- Depending on the design:
 1. Strip the protective tubes **(7)**.
 Secure the protective tubes to the rear panel with cable ties.
 Route the bundled loose tube fibres into the protective tubes.
 2. Strip the corrugated tube **(8)**.
 Secure the corrugated tube to the rear panel with cable ties.
 Guide the bundled loose tube fibres into the corrugated tube.
- Fix the core of fibre cable in place with a clamping yoke screw **(2)**.
- Fasten the optical fibre mini cables / air cables **(6)** to the rear panel with cable ties **(5)**.
- Bundle the protective tubes / corrugated tube / bundled loose tube fibres using guide rings **(2)** and route them via the cable diverter **(1)** to the fibre tray level.

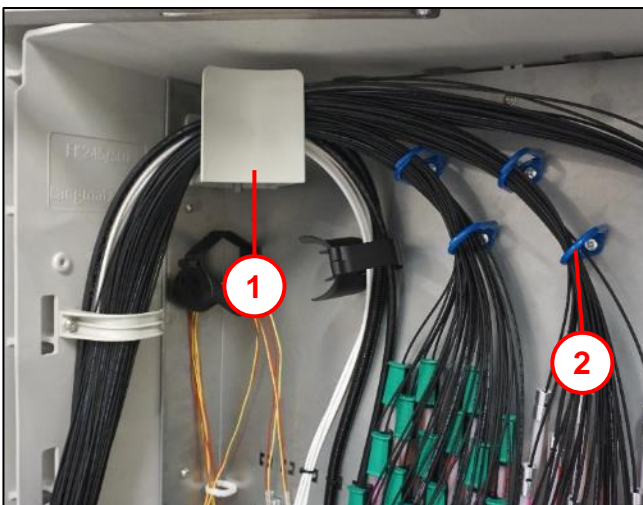

Fig. 23

8.2 Loop

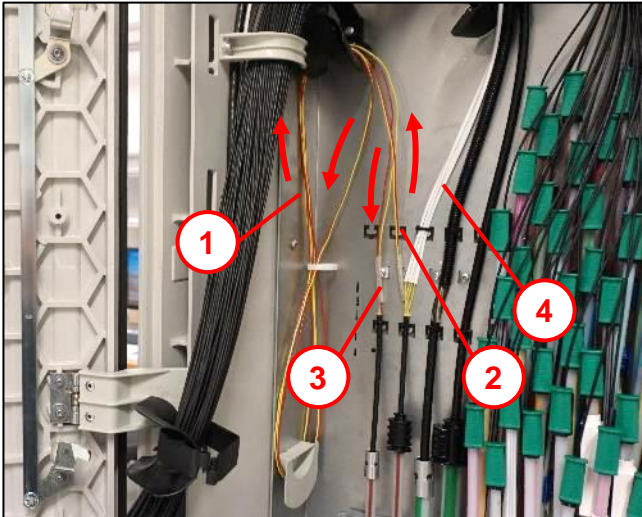

Fig. 24

- Bundled loose tube fibres to the excess cable tray (2).
- Outlet of the bundled loose tube fibres (3) (bundled loose tube fibres/cables from the cabinet).
- Bundled loose tube fibres via the cable diverter for loop excess storage (1).
Note: Lay excess length in a figure of eight.
- Cut fibres in bundled loose tube fibres to the fibre tray system level on the door (4).

8.3 Conversion option for micro cable organiser and cable organiser access

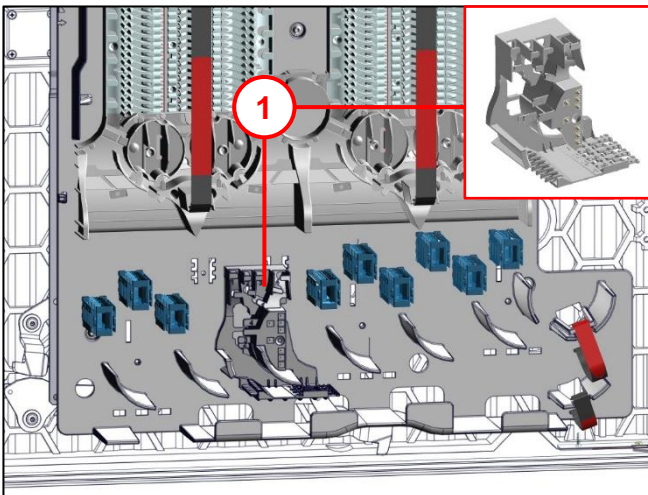

Fig. 25

- The cable organiser access (1) can be mounted in four different positions (see Fig. 26).
- Standard installation as shown (position three).

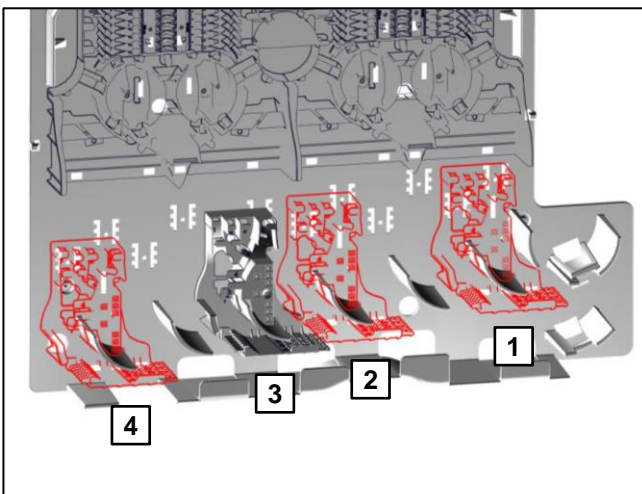

Fig. 26

Possible positions (1–4) with three recesses for insertion of the cable organiser in each case.

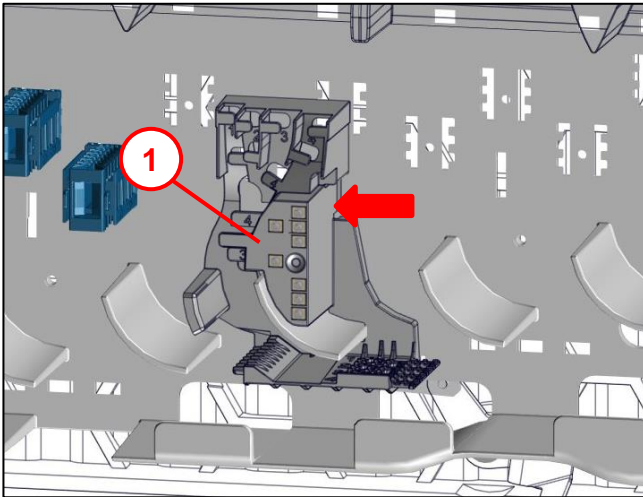

Fig. 27

- Press and engage the cable organiser **(1)** at this point (as close as possible to the mounting panel).
- Remove the cable organiser and reinsert at the required position.

Note:

When using 3x hooks, insert into 3x recesses on the rear panel. Press and engage the cable organiser onto the mounting panel.

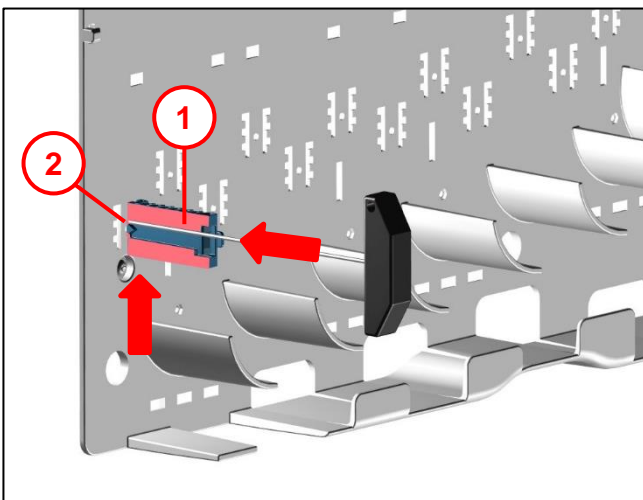

Fig. 28

Cross-sectional view of the micro cable organiser

- To dismantle, use a hex screwdriver (AF 2 / 2.5) to press through the micro cable organiser **(1)** onto the mounting panel **(2)**.
- **Note:** Use the upper drill hole!
- Push the micro cable organiser up and remove.

8.4 Ongoing routing of main cable / mini cables / bundled loose tube fibres

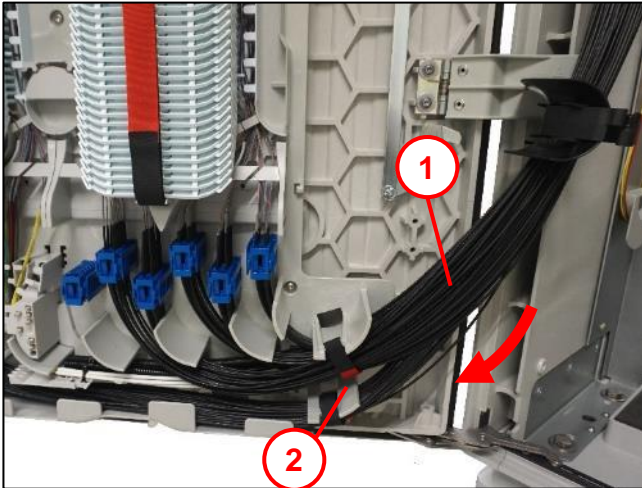

Fig. 29

- Continue routing the bundled loose tube fibres / corrugated tube / protective tube (1).
- Secure the cable harness with a hook-and-loop strap (2).

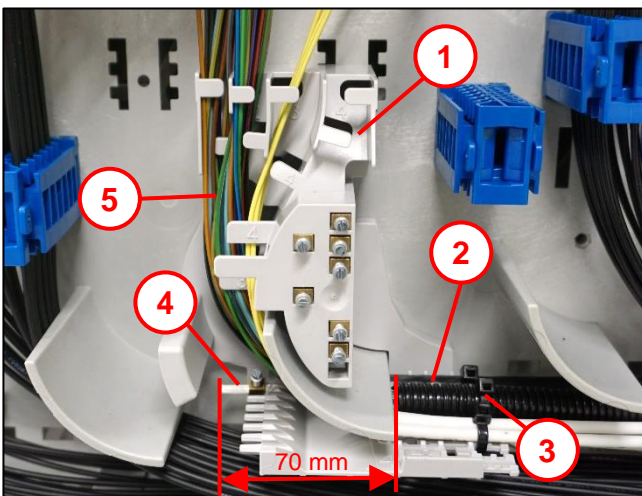

Fig. 30

- Depending on the design:
 - Attach the protective tube / corrugated tube (2) to the cable organiser (1) with cable ties (3).
 - Strip the protective tube / corrugated tube.
- Guide the bundled loose tube fibres (5) through the cable organiser access into the end piece.
- Strip the core of fibre cable (4) to 70 mm.
- Insert the core of fibre cable into the bay, push on the clamping yoke and screw in place.
- Shorten the protruding core of fibre cable.

9 Micro cable assembly in the outlet area

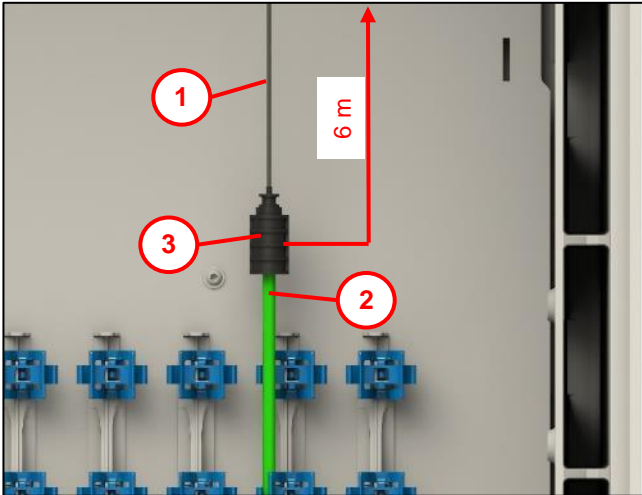

Fig. 31

- Insert the micro cables 2.5–4.0 mm **(1)** into the micro-duct pipe **(2)**.
Note: The length of the optical fibre micro cable must be, for example 6 m, from the cutting edge (depending on the specification).
- Seal the micro cables with a micro-duct gas stop **(3)** (referring to the manufacturer's installation instructions).

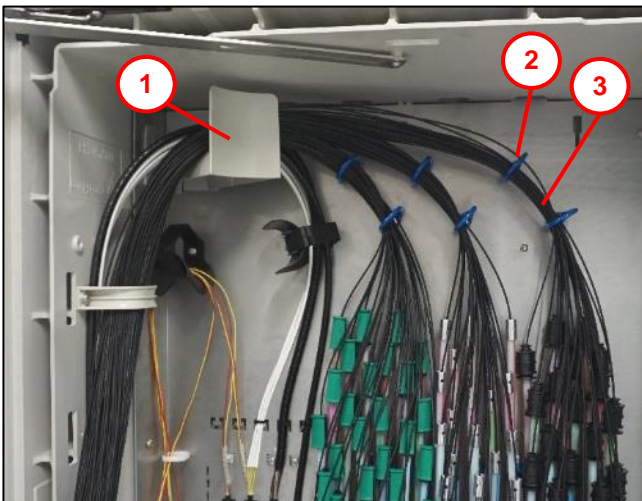

Fig. 32

- Route the optical fibre micro cables **(3)** through the guide rings **(2)** on the rear panel.
- Route the optical fibre micro cables via the cable diverter **(1)** at fibre tray level.

10 Inserting the micro cables (at fibre tray level)



Fig. 33

- The strain relief of the mini cable and organisation of the micro cables is done below the fibre management area.

Note:

- Ensure sufficiently loose routing around the optical fibre radius limiters when organising micro cables.
- The micro cable organiser shown below is for a cable diameter of $\varnothing 1.2\text{--}2.5$ mm (grey) or $\varnothing 2.3\text{--}4.6$ (blue).

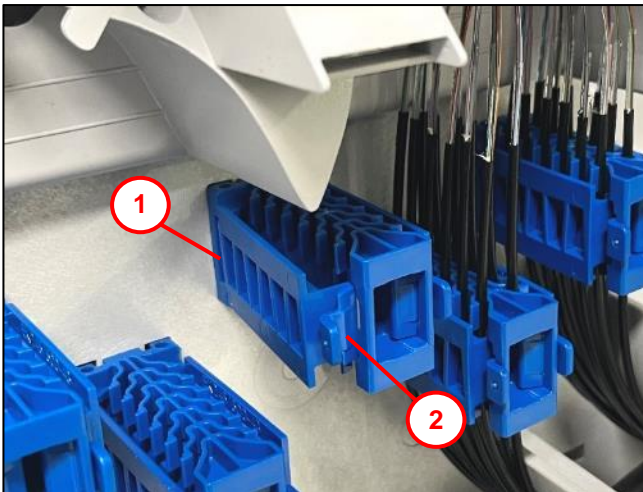

Fig. 34

- Push the snap tab (2) backwards.
- Swivel the cover (1) outwards and remove it.

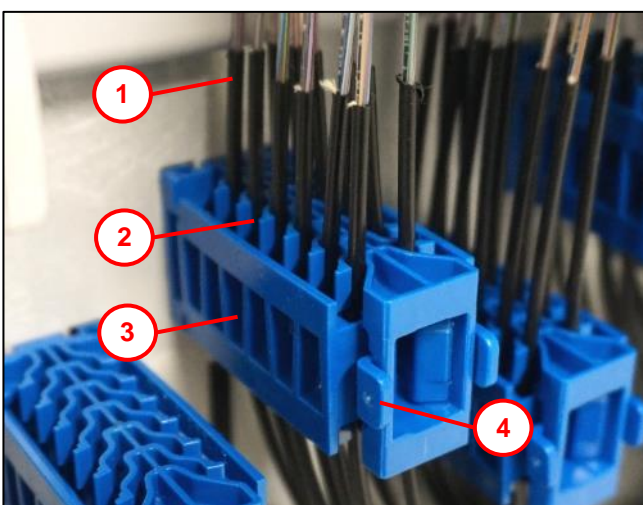

Fig. 35

- Press the micro cable (1) into the clamping points (2), referring to Fig. 36 for the length to be stripped above the clamping points.
- **Note:** Start the assignment from the back to the front to simplify organisation.
- Insert the cover (3). Push the cover back and swivel it fully in until the snap tab (4) audibly clicks into place.

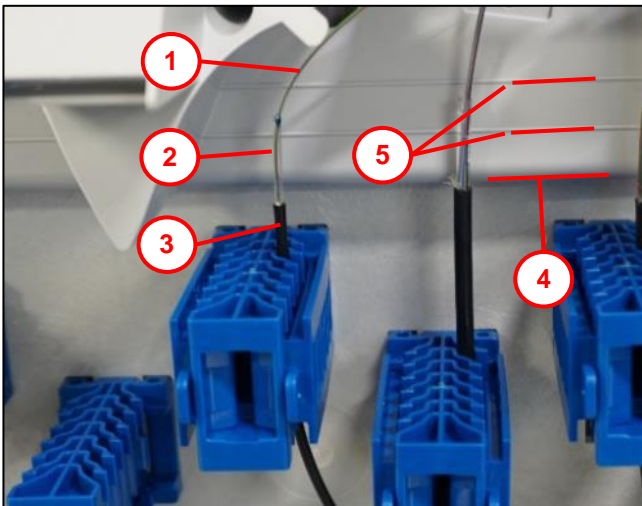

Fig. 36

- Strip the micro cables **(3)** at the lower edge of the end piece **(4)**.
- Strip the bundled loose tube fibres **(2)** between the two designated lines **(5)** of the end piece and guide the optical fibres **(1)** into the fibre management area.

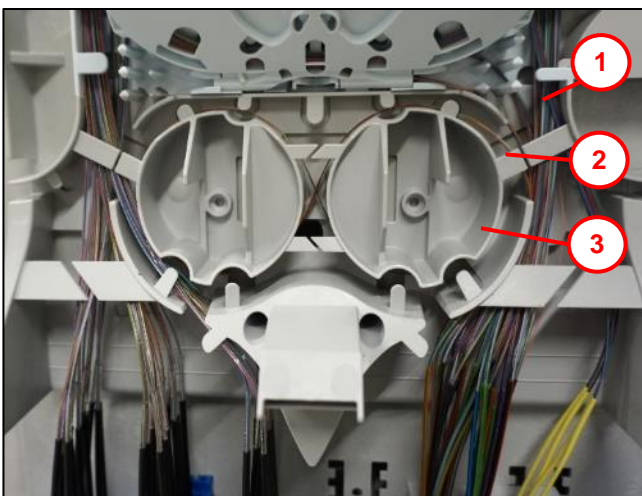

Fig. 37

- Change the fibre ducts **(1)** on the left - right within an end piece **(2)** and route the fibres over the fibre management spools **(3)**.

11 Use of the protective cover

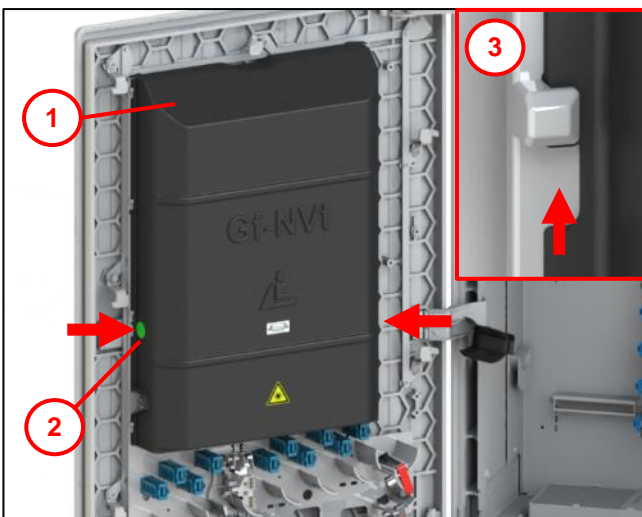

Fig. 38

- At the bottom of the protective cover **(1)**, press the green points **(2)** on both sides to loosen the cover.
- Push the protective cover upwards so that the cover is pushed out of the fixing wedges **(3)** (4 on each side).

12 Description of the Langmatz fibre tray system

12.1 Mounting panel

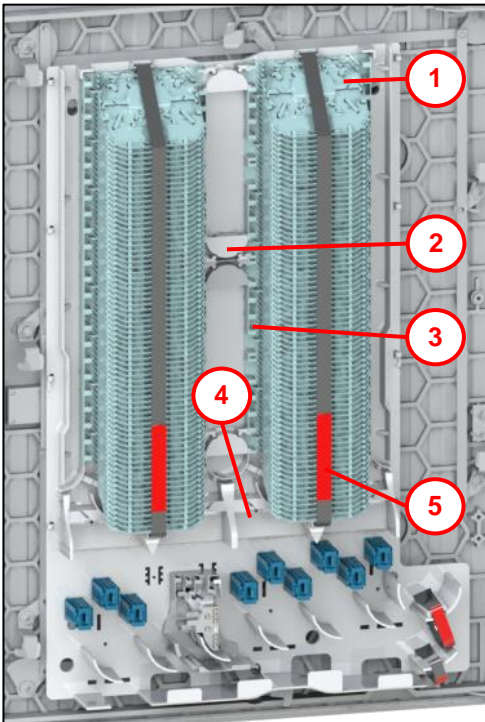

Fig. 39

Pos. 1 Optical fibre trays

Pos. 2 Fibre bridges
cross switching

Pos. 3 Organiser module (basic element) to hold
fibre trays with fibre routing

Pos. 4 End piece with fibre guide area

Pos. 5 Hook-and-loop strap

Note: Slightly tighten and fix the hook-and-loop strap.

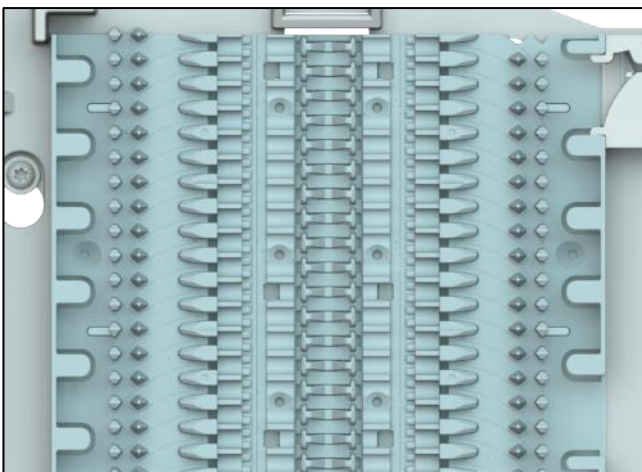
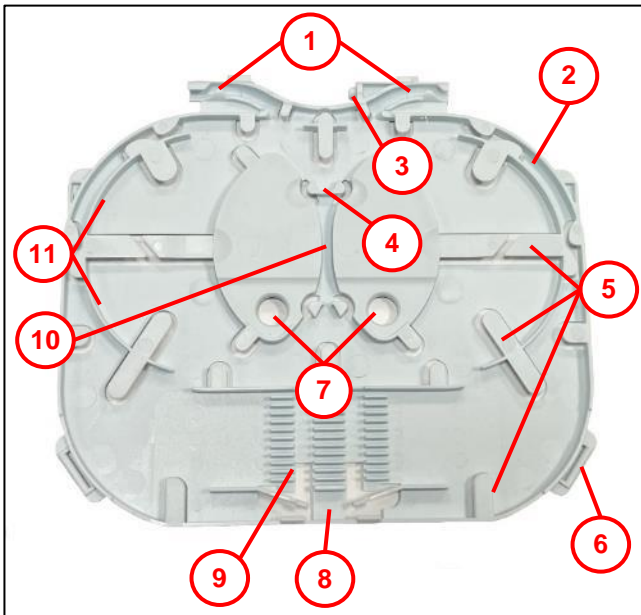

Fig. 40

- Every organiser module has space for 18x 5 mm fibre trays and/or 9x 10 mm fibre trays.
- Depending on the design, fibre trays do not form part of the scope of supply.
- Tool-free installation of the fibre trays.
- Removal using the installation tool supplied.
- Total capacity 144x 5 mm fibre trays or 72x 10 mm fibre trays.

12.2 Description of the splice fibre tray



- Pos. 1** Fibre input / fibre outlet channel
- Pos. 2** Outer fibre storage
- Pos. 3** Snap lug
- Pos. 4** Termination mount
- Pos. 5** Down-holder for fibres
- Pos. 6** Mounting for marking rings
- Pos. 7** Mounting for cover
- Pos. 8** Mounting option for coupler/splitter
- Pos. 9** Storage for crimp splice protector
- Pos. 10** Guide for direction switch
- Pos. 11** Internal fibre placement

Fig. 41

12.3 Inserting the fibre tray

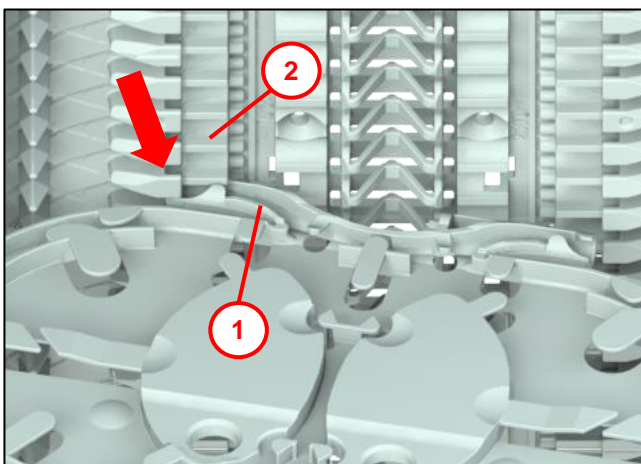

- Position the fibre tray with fibre channel **(1)** on the left into the round recess on the organiser module **(2)**.

Fig. 42

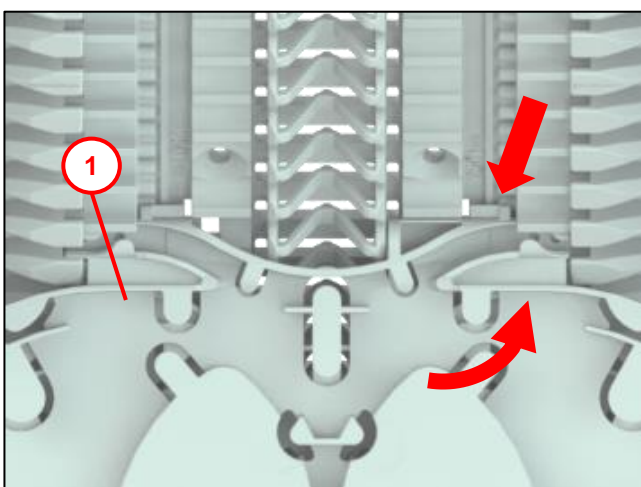

- Engage the fibre tray **(1)** down and to the right.

Fig. 43

12.4 Removing the fibre tray

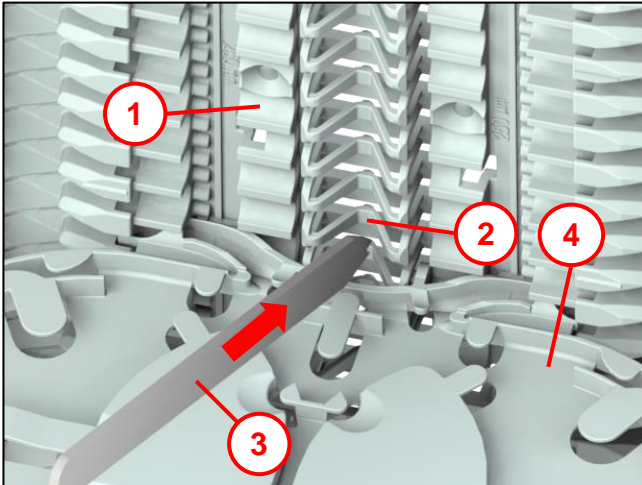

Fig. 44

- To remove it, position the fibre tray **(4)** vertically to the organiser **(1)**.
- To remove the fibre tray, press the centre of the resting mount **(2)** downwards with the installation tool **(3)**.
- Remove the fibre tray.

13 Inserting and splicing optical fibres

13.1 Inlet fibres to the fibre tray

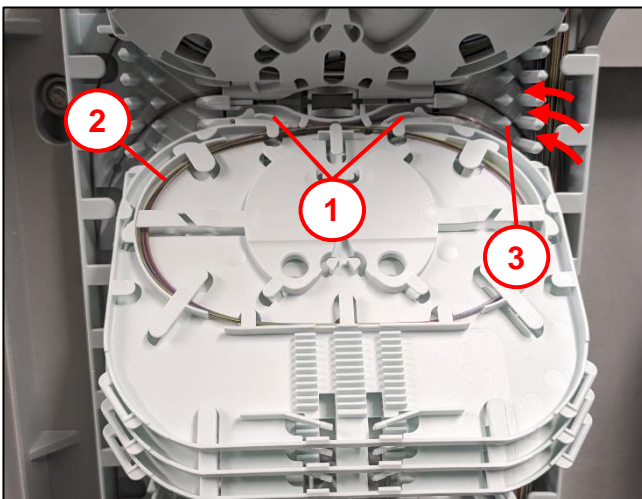

Fig. 45

- Route the optical fibres **(2)** over the guide **(3)** on the organiser module to the fibre tray.
- Insertion into the fibre tray through the fibre inlet / fibre outlet channel **(1)**.

13.2 Splicing fibres

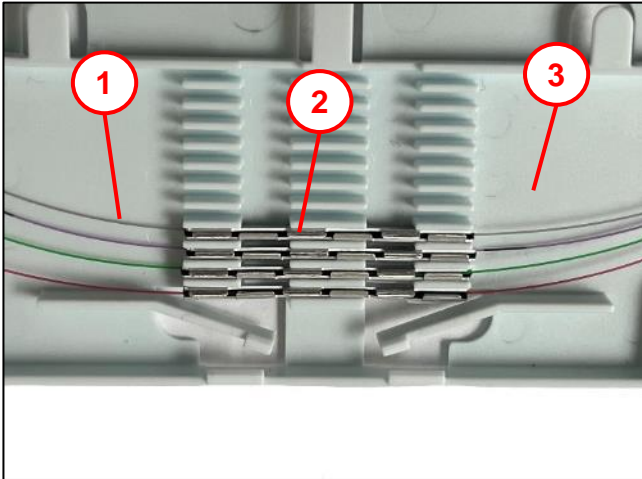

Fig. 46

- Determine the fibre lengths according to the specification.
- Splice fibres (1).
- Place the crimp splice protection (2) in the splice protection holder (3).

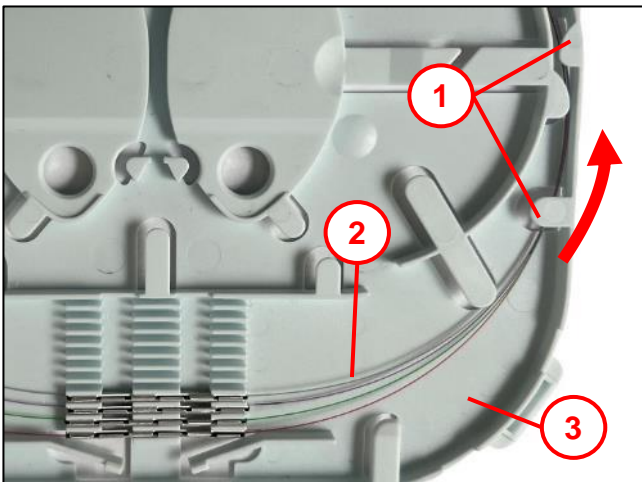

Fig. 47

- Place the optical fibres (2) starting from the left or right into the outer fibre placement (3) under the down-holder (1).
- Guide the optical fibres downwards in a semicircle.

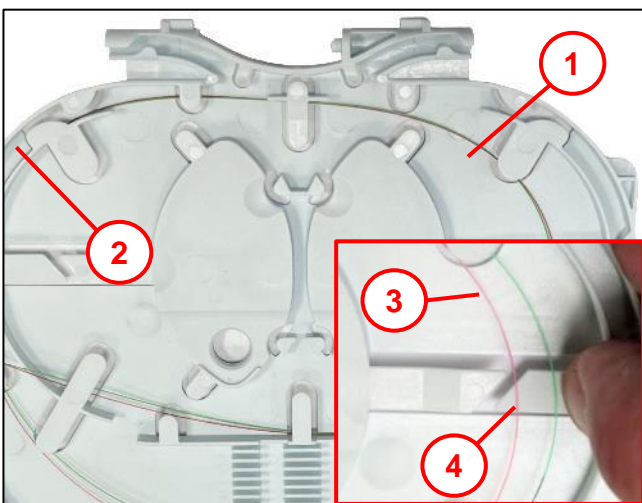

Fig. 48

- Change the optical fibres from the outer fibre placement (2) to the inner fibre placement (1).
- Press the large down-holder (4) when inserting the optical fibres (3).
- Store the fibres in the inner fibre placement and insert a minimum or three of more fibre windings.

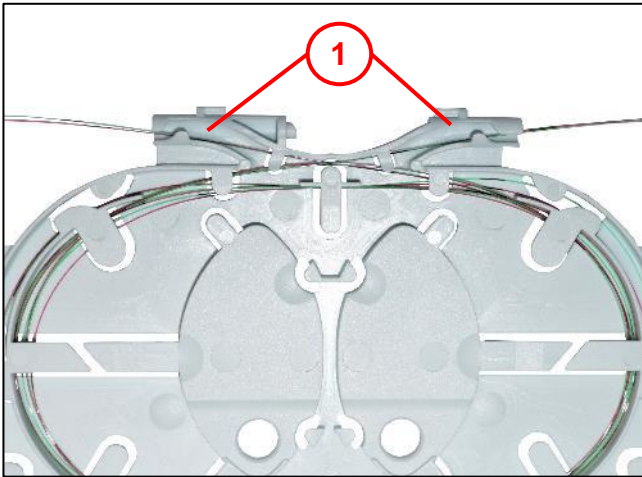

Fig. 49

- Finally check whether all optical fibres are correctly placed in the fibre inlet / fibre outlet channels **(1)** and are below the down-holder.
-

13.3 Change in direction of the fibres in the fibre tray

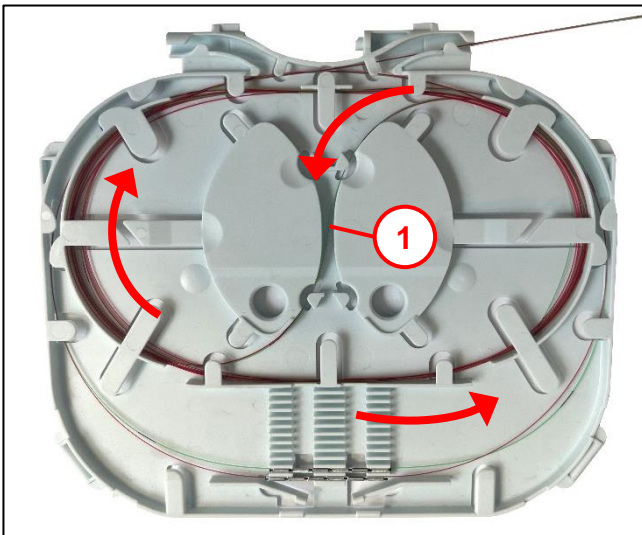

Fig. 50

- When changing the direction of the optical fibres, do so in the middle area of the fibre tray **(1)** as shown (creating a "figure of eight").

13.4 Side optical fibre cable guide

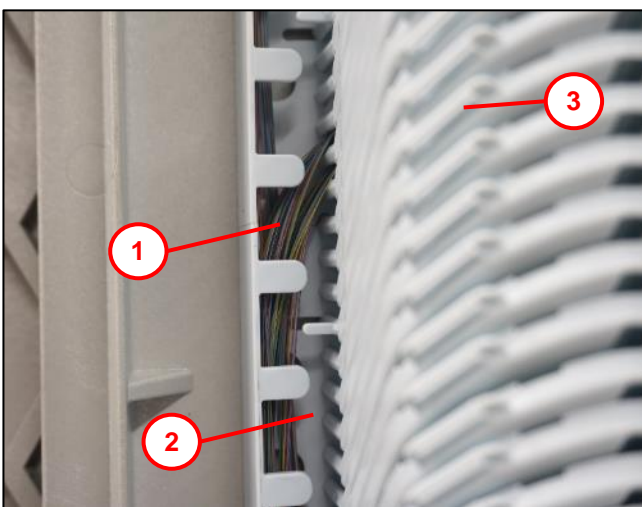

Fig.

- Guide the optical fibres **(1)** along the guide **(2)** to the fibre tray **(3)**.

13.5 Fibre bridge

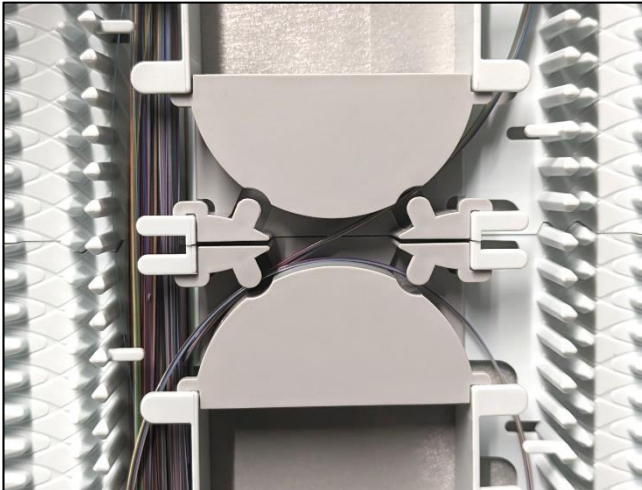

Fig. 51

- There are 4 single-fibre bridges between the rows of fibre trays for manoeuvring between the two fibre tray stacks.
- Bridges provide the necessary protection and ensure the minimum bending radius of the fibres.

13.6 Fibre tray cover

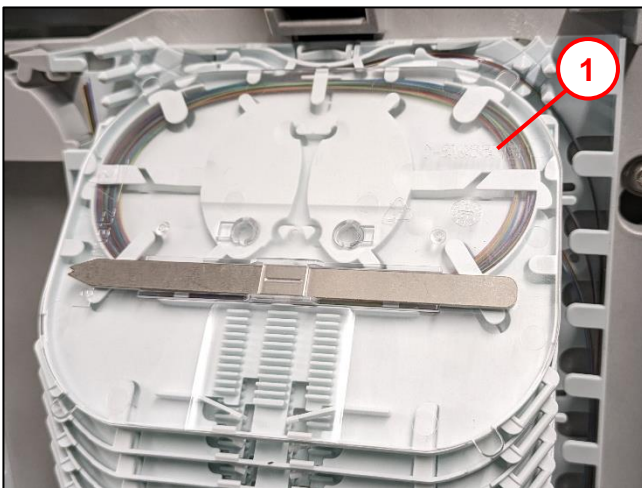

Fig. 52

- The top fibre tray is fitted with a transparent cover (1) to protect the fibres and splices.
- All other fibre trays are protected by the respective fibre tray above.

14 Cabinet replacement

Note: If only the door needs to be replaced, continue with 14.4.

14.1 Removing the earthing

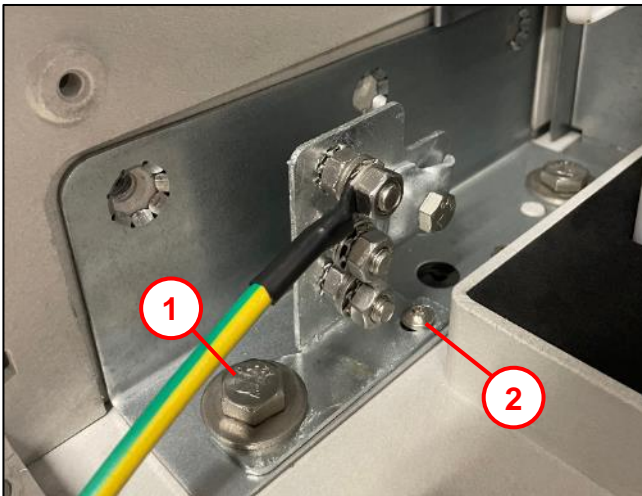

Fig. 53

- Remove earthing (if fitted).
- Slightly loosen 1x hex screw M10x50 **(1)** with an AF19.
- Remove 1x fastening screw 5x12 **(2)** with a Torx TX25.

14.2 Removing the rear panel

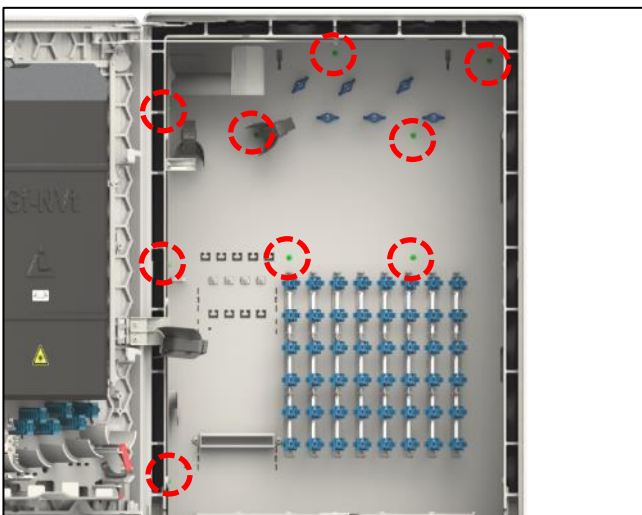

Fig. 54

- Remove 9x thermoplastic screws K60x16 with a Torx TX25.

14.3 Removing the brackets

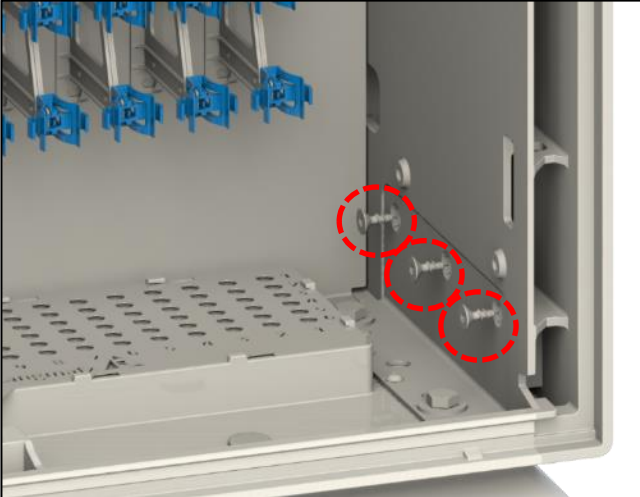

Fig. 55

- Remove 1x thermoplastic screw 80x20 on each bracket (left and right) with a Torx TX40.

14.4 Removing the cable routing



Fig. 56

- Remove the cable routing (1).
- Remove 1x thermoplastic screw plus 50x12 with a Torx TX25.

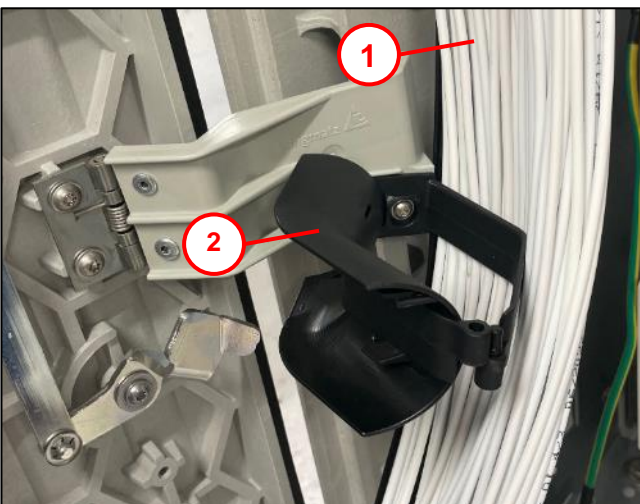

Fig. 57

- Open the cable routing (2) and remove the cables (1) from the cable routing.

14.5 Loosening the mounting panel

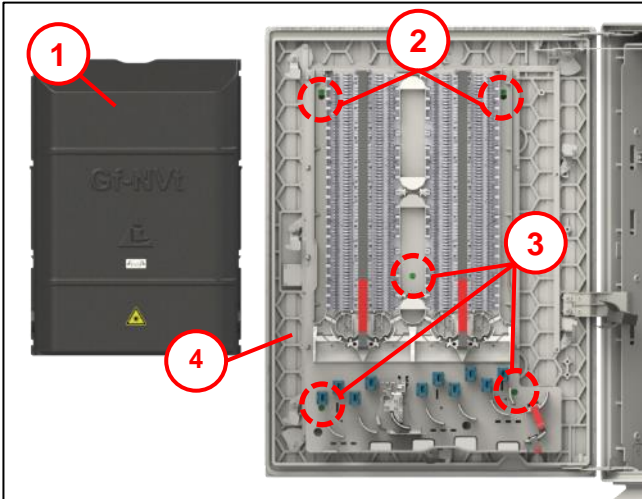

Fig. 58

- Remove the cover **(1)**, referring to section 11.
- Slightly loosen 2x thermoplastic screws K60x16 **(2)** with a Torx TX25.
- Remove 3x thermoplastic screws K60x16 **(3)** with a Torx TX25.
- Detach the mounting panel **(4)** via the key holes upwards.

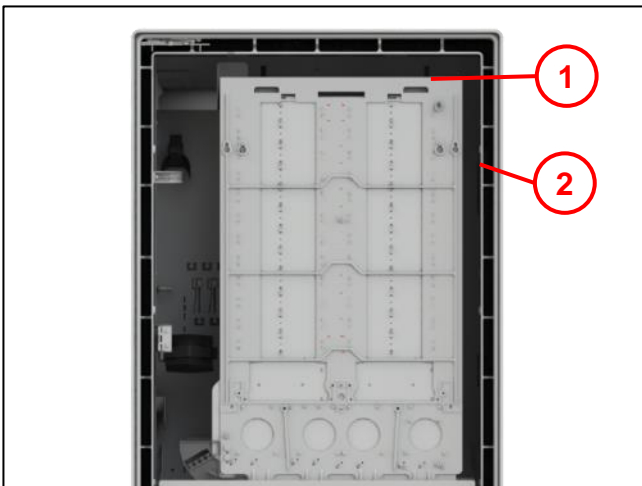

Fig. 59

- Position the mounting panel **(1)** in the cabinet **(2)**.

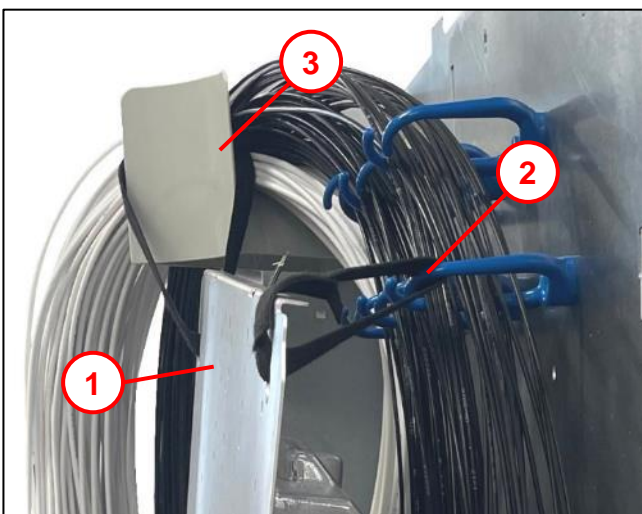

Fig. 60

- Attach the mounting panel **(1)** to the guide ring **(2)** and cable diverter **(3)**.

14.6 Releasing the door

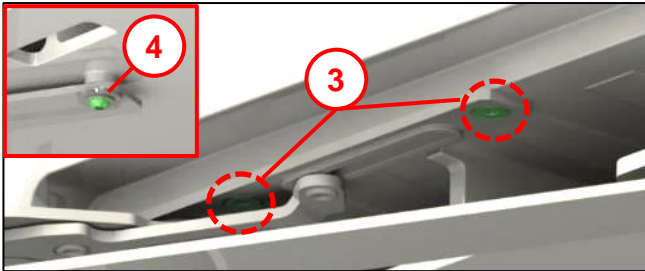
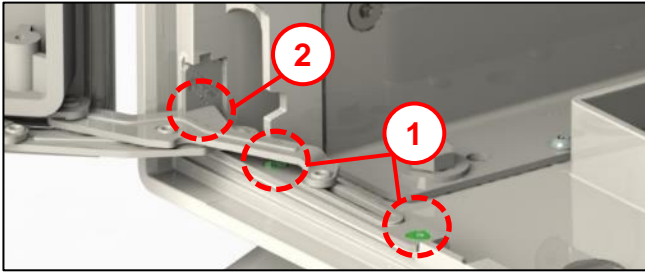

Fig. 61

- Remove the door.
- Loosen 2x thermoplastic screws 50x16 **(1)** with a Torx TX25 on the lower door hinge.
- Loosen 2x thermoplastic screws 50x16 **(2)** with a Torx TX25 on the lower door hinge.
- Note:** The door must be closed slightly for this!
- Loosen 2x thermoplastic screws 50x16 **(3)** with a Torx TX25 on the upper door hinge.
- Loosen 1x screw **(4)** with a Torx TX25 on the door adjuster.

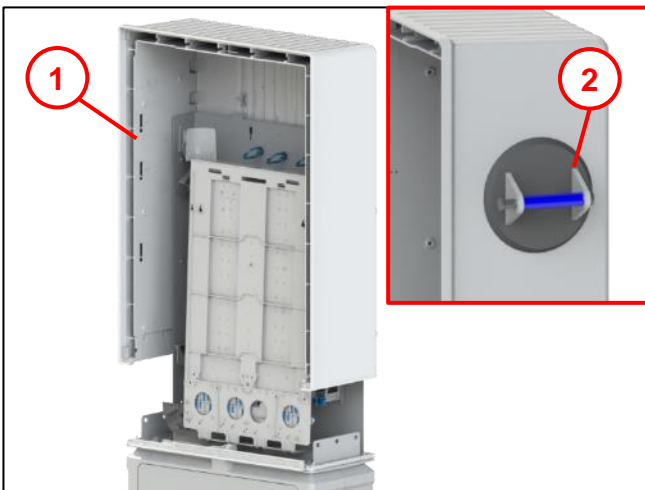

Fig. 62

- Carefully lift the cabinet **(1)** upwards using the installation kit.
- Note:** An appropriate suction lifter **(2)** can be used to lift the cabinet.
- Place the new cabinet on the pedestal and reinstall the door hinges as shown in Fig. 61.

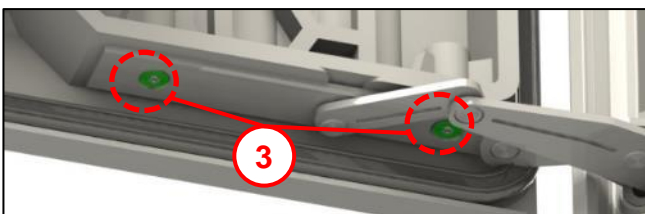
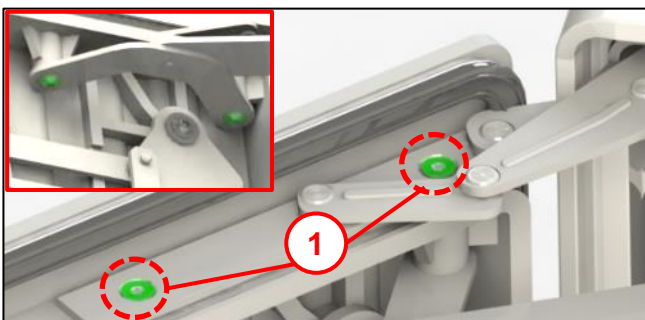

Fig. 63

- Attach the door hinges to the door with 2x thermoplastic screws 50x16 at the top **(1)** and 2x thermoplastic screws 50x16 at the bottom **(2)** using a Torx TX25.

Then perform Figs. 65 to 74 in reverse order.

15 Double swivel lever

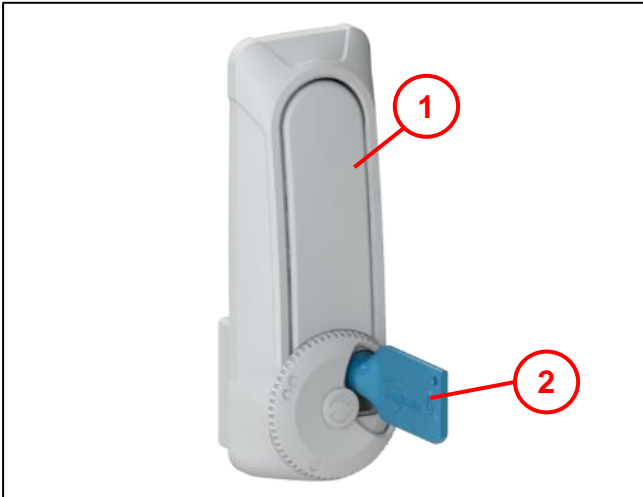

Fig. 64

- Open the swivelling lever handle (1) with the cabinet/manhole key (2).



Fig. 65

- Insert the profile half-cylinder (2) from the rear or from the front (depending on the make) into the swivel lever handle (1).
- Adjust the depth of the profile half-cylinder until the fastening screw (3) can engage in the thread.
- Tighten the fastening screw.

Note: A blind cylinder can be used with a double swivel lever if a profile half-cylinder opening is temporarily not used (usually factory installed).

See also the EMKA installation instructions:
https://www.emka.com/de_en/vlink-0000000063



16 Earthing

16.1 Earthing kit

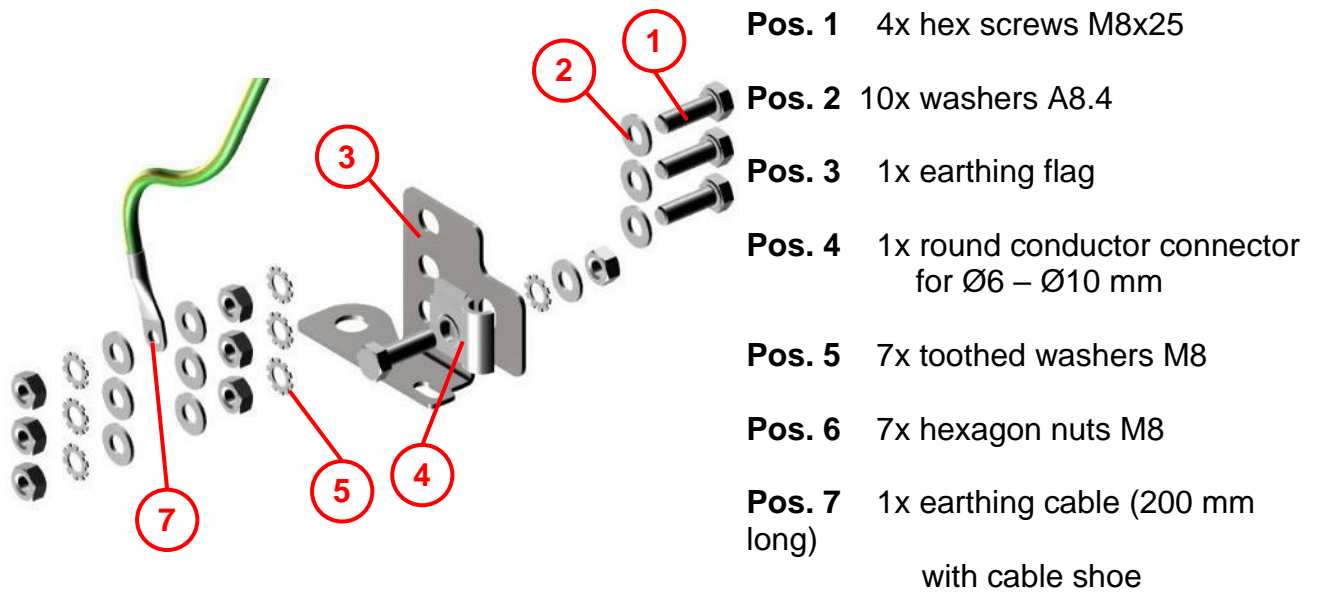

Fig. 66

16.2 Preparation

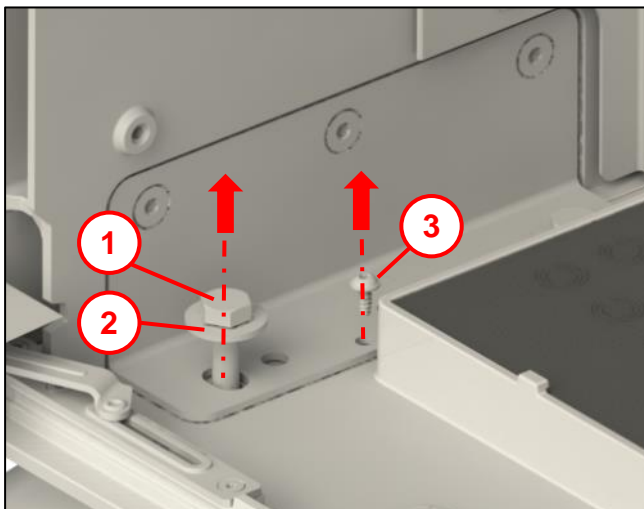

Fig. 67

Remove from the base plate (front left in the KVz22):

- 1x hex screw M10x50 **(1)**,
1x washer **(2)**,
1x fastening screw for plastic 5x12 **(3)**

16.3 Pre-assembly of the earthing flag

16.3.1 Installation of the earthing cable (1x)

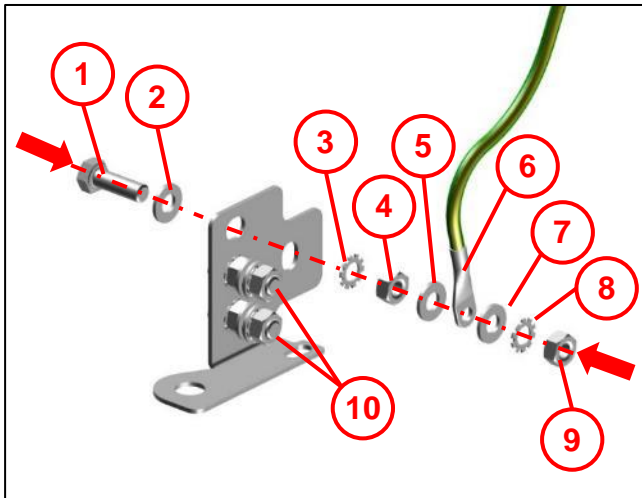

Fig. 68



Note the sequence!

- **Rear:**
 - 1 Fit 1x hex screw M8x25 with
 - 2 1x washer.
- **Front:**
 - 3 Fit 1x toothed washer M8;
 - 4 1x hexagon nut M8;
 - 5 1x washer A8.4;
 - 6 1x earthing cable;
 - 7 1x washer A8.4;
 - 8 1x toothed washer M8;
 - 9 1x hexagon nut M8.

Pre-assemble the screw connections for the second and third earthing cable **(10)** as described.

16.3.2 Installation of the cable holder for Ø6 mm - Ø10 mm

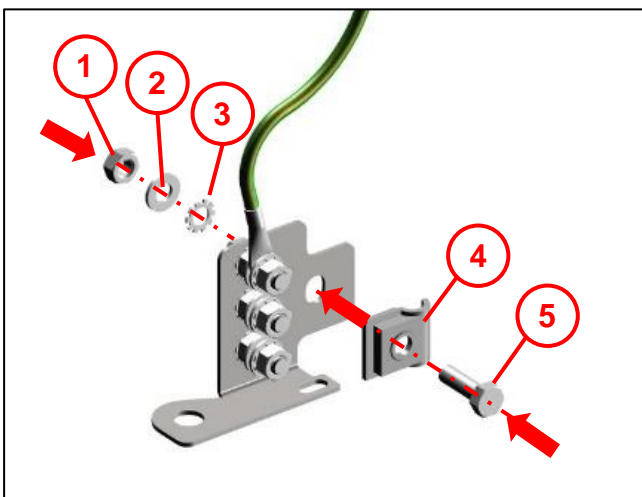

Fig. 69



Note the sequence!

- **Rear:**
 - 1 Fit 1x hexagon nut M8;
 - 2 1x washer A8.4;
 - 3 1x toothed washer M8.
- **Front:**
 - 4 Fit 1x round conductor connector for Ø6 mm – Ø10 mm
 - 5 Fit 1x hex screw M8x25

16.4 Installing the earthing flag in the KVz22

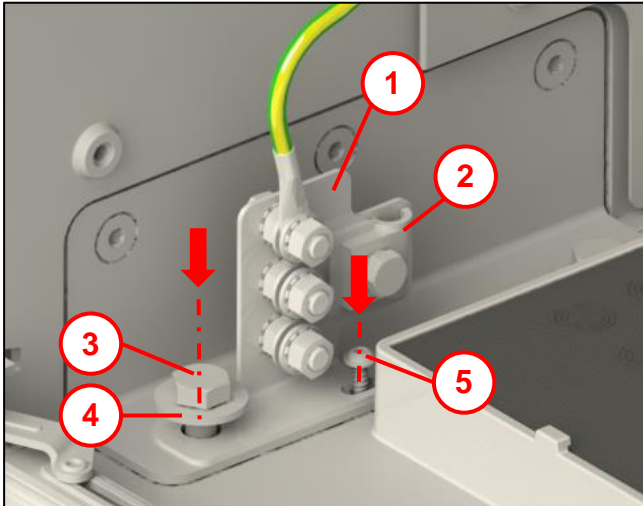

Fig. 70

- Insert the complete earthing flag **(1)** in the KVz22.
- Fit the screws previously removed (see Fig. 3) on the base plate.
 - 1x hex screw M10x50 **(3)**.
 - 1x washer **(4)**.
 - 1x fastening screw for plastic 5x12 **(5)**.
- Fix the earthing cable in the round conductor connection **(2)**.

17 Material defects

Langmatz accepts liability for material defects in the product as per Section 434 BGB (German Civil Code) for 24 months, starting from the date on the purchase receipt.

Within the scope of liability, all parts that become damaged due to manufacturing faults or material defects will be replaced or repaired free of charge.

The purchaser must report any deficiency complaints immediately in writing.

Claims by the purchaser for damages due to material defects or for whatever legal reason will not be accepted.

Any damage or failure caused by the following are also excluded from liability:

incorrect use,

natural wear and tear,

intervention by third parties.

We accept no liability for damage caused by force majeure or transport.

Repairs due to a complaint about a defect do not extend the warranty period for the replaced parts or for the product.

This product conforms to the latest state-of-the-art technology. Nevertheless, if you experience any problems with it, please contact our hotline (chapter 20).

18 Recycling

The materials mainly used for the optical fibre distribution cabinet are polycarbonate and ABS and are fully recyclable.

19 Cleaning, repainting

Normally soiled cabinets can be cleaned with standard household cleaning agents.

The cabinets can be coated with a two-component paint on site.

20 Quality management

Langmatz GmbH's quality management system is certified according to DIN EN ISO 9001.

21 Disclaimer/Warranty

The information in this technical document is presented appropriately and correctly in compliance with the technical regulations, and to the best of our knowledge. However, this does not confer any guarantee of particular characteristics. In this context, the company that operates the products supplied by Langmatz GmbH is expressly obliged to decide, based on its own judgement, whether the products are suitable and appropriate for the application or use being considered. The product liability accepted by Langmatz GmbH relates exclusively to our conditions of sale, delivery, and payment. Langmatz GmbH accepts no liability on the basis of random, indirect and resultant consequential damage, or of any damage attributable to any use of the product other than its intended purpose as described.

22 Contact

Langmatz GmbH | Am Gschwend 10
82467 Garmisch-Partenkirchen, Germany

Our hotline: +49 88 21 920 – 137

Phone: +49 8821 920 – 0

Email: info@langmatz.de | www.langmatz.de